



R410A

Commercial Air Conditioners

Service Manual



4TVY0077HE000AA

4TVY0192HE000AA

4TVY0096HE000AA

4TVY0210HE000AA

4TVY0115HE000AA

4TVY0229HE000AA

4TVY0140HE000AA

4TVY0249HE000AA

4TVY0155HE000AA

4TVY0268HE000AA

4TVY0170HE000AA

4TVY0290HE000AA

CONTENTS

Part 1 General Information.....	3
Part 2 Component Layout and Refrigerant Circuits	11
Part 3 Control	23
Part 4 Field Settings.....	33
Part 5 Electrical Components and Wiring Diagrams	39
Part 6 Diagnosis and Troubleshooting.....	55

Part 1

General Information

1 Indoor and Outdoor Unit Capacities	4
2 External Appearance	6
3 Outdoor Unit Combinations	8
4 Combination Ratio	10

1 Indoor and Outdoor Unit Capacities

1.1 Indoor Units

1.1.1 Standard indoor units

Table 1-1.1: Standard indoor unit abbreviation codes

Abbreviation code	Type
Q1	One-way Cassette
Q2	Two-way Cassette
Q4C	Compact Four-way Cassette
Q4	Four-way Cassette
T2	Medium Static Pressure Duct

Abbreviation code	Type
T1	High Static Pressure Duct
G	Wall-mounted
DL	Ceiling & Floor
F	Floor Standing

Table 1-1.2: Standard indoor unit capacity range

Capacity		Capacity index	Q1	Q2	Q4C	Q4	T2	T1	G	DL	F
kW	HP										
1.8	0.6	18	18	—	—	—	—	—	—	—	—
2.2	0.8	22	22	22	22	—	22	—	22	—	22
2.8	1	28	28	28	28	28	28	—	28	—	28
3.6	1.25	36	36	36	36	36	36	—	36	36	36
4.5	1.6	45	45	45	45	45	45	—	45	45	45
5.6	2	56	56	56	—	56	56	—	56	56	56
7.1	2.5	71	71	71	—	71	71	71	71	71	71
8.0	3	80	—	—	—	80	80	80	80	80	80
9.0	3.2	90	—	—	—	90	90	90	90	90	—
10.0	3.6	100	—	—	—	100	—	—	—	—	—
11.2	4	112	—	—	—	112	112	112	—	112	—
14.0	5	140	—	—	—	140	140	140	—	140	—
16.0	6	160	—	—	—	—	—	160	—	160	—
20.0	7	200	—	—	—	—	—	200	—	—	—
25.0	9	250	—	—	—	—	—	250	—	—	—
28.0	10	280	—	—	—	—	—	280	—	—	—
40.0	14	400	—	—	—	—	—	400	—	—	—
45.0	16	450	—	—	—	—	—	450	—	—	—
56.0	20	560	—	—	—	—	—	560	—	—	—

1.1.2 Fresh air processing unit

Table 1-1.3: Fresh air processing unit capacity range

Capacity	12.5kW	14kW	20kW	25kW	28kW	45kW	56kW
Capacity index	125	140	200	250	280	450	560

1.2 Heat recovery ventilator

Table 1-1.4: Heat recovery ventilator capacity range

Capacity	200m ³ /h	300m ³ /h	400m ³ /h	500m ³ /h	800m ³ /h	1000m ³ /h	1500m ³ /h	2000m ³ /h
----------	----------------------	----------------------	----------------------	----------------------	----------------------	-----------------------	-----------------------	-----------------------

1.3 Outdoor Units
Table 1-1.5: Outdoor unit capacity range

Capacity	Model Name	Combination Type
8HP	4TVY0077HE000AA	/
10HP	4TVY0096HE000AA	/
12HP	4TVY0115HE000AA	/
14HP	4TVY0140HE000AA	/
16HP	4TVY0155HE000AA	/
18HP	4TVY0170HE000AA	/
20HP	4TVY0192HE000AA	/
22HP	4TVY0210HE000AA	/
24HP	4TVY0229HE000AA	/
26HP	4TVY0249HE000AA	/
28HP	4TVY0268HE000AA	/
30HP	4TVY0290HE000AA	/
32HP	4TVY0310HE000AA	16HP+16HP
34HP	4TVY0325HE000AA	22HP+12HP
36HP	4TVY0347HE000AA	20HP+16HP
38HP	4TVY0365HE000AA	22HP+16HP
40HP	4TVY0384HE000AA	24HP+16HP
42HP	4TVY0404HE000AA	26HP+16HP
44HP	4TVY0423HE000AA	28HP+16HP
46HP	4TVY0445HE000AA	30HP+16HP
48HP	4TVY0459HE000AA	26HP+22HP
50HP	4TVY0478HE000AA	28HP+22HP
52HP	4TVY0500HE000AA	30HP+22HP
54HP	4TVY0517HE000AA	28HP+26HP
56HP	4TVY0536HE000AA	28HP+28HP
58HP	4TVY0558HE000AA	30HP+28HP
60HP	4TVY0580HE000AA	30HP+30HP
62HP	4TVY0600HE000AA	30HP+16HP+16HP
64HP	4TVY0614HE000AA	26HP+22HP+16HP
66HP	4TVY0633HE000AA	28HP+22HP+16HP
68HP	4TVY0655HE000AA	30HP+22HP+16HP
70HP	4TVY0672HE000AA	28HP+26HP+16HP
72HP	4TVY0691HE000AA	28HP+28HP+16HP
74HP	4TVY0713HE000AA	30HP+28HP+16HP
76HP	4TVY0735HE000AA	30HP+30HP+16HP
78HP	4TVY0746HE000AA	28HP+28HP+22HP
80HP	4TVY0768HE000AA	30HP+28HP+22HP
82HP	4TVY0790HE000AA	30HP+30HP+22HP
84HP	4TVY0804HE000AA	28HP+28HP+28HP
86HP	4TVY0826HE000AA	30HP+28HP+28HP
88HP	4TVY0848HE000AA	30HP+30HP+28HP
90HP	4TVY0870HE000AA	30HP+30HP+30HP

Notes:

- The combinations of units shown in the table are factory-recommended. Other combinations of units are also possible.

2 External Appearance

2.1 Indoor Units

2.1.1 Standard indoor unit

Table 1-2.1: Standard indoor unit appearance

One-way Cassette Q1 	Two-way Cassette Q2 
Compact Four-way Cassette Q4C 	Four-way Cassette Q4 
Medium Static Pressure Duct T2 	High Static Pressure Duct T1 
Wall-mounted G 	Ceiling & Floor DL 
Floor Standing F 	

2.1.2 Fresh air processing unit

Table 1-2.2: Fresh air processing unit appearance

Fresh Air Processing Unit FA 
--

2.2 Heat Recovery Ventilator

Table 1-2.3: Heat recovery ventilator appearance

Heat Recovery Ventilator 

2.3 Outdoor Units
2.3.1 Single units
Table 1-2.4: Single outdoor unit appearance

8/10/12/14/16HP (with single fan)	18/20/22HP (with dual fans)	24/26/28/30 (with dual fans)
		

2.3.2 Combinations of units
Table 1-2.5: Combination outdoor unit appearance

<p data-bbox="395 801 464 833">32HP</p> 	<p data-bbox="1050 801 1209 833">34/36/38/HP</p> 
<p data-bbox="338 1137 523 1169">40/42/44/46HP</p> 	<p data-bbox="1056 1137 1203 1169">48/50/52HP</p> 
<p data-bbox="338 1473 523 1505">54/56/58/60HP</p> 	<p data-bbox="1098 1473 1161 1505">62HP</p> 
<p data-bbox="357 1809 504 1841">64/66/68HP</p> 	<p data-bbox="1040 1809 1225 1841">70/72/74/76HP</p> 

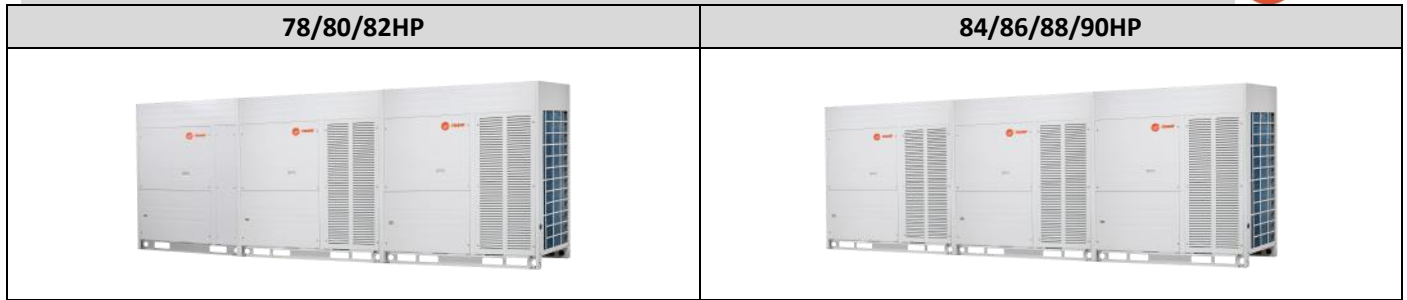

3 Outdoor Unit Combinations

Table 1-3.1: Outdoor unit combinations

System capacity		Number of units	Modules ¹												Outdoor branch joint kit ²		
kW	HP		8	10	12	14	16	18	20	22	24	26	28	30			
22.4	8	1	•														
28.0	10	1		•													
33.5	12	1			•												
40.0	14	1				•											
45.0	16	1					•										
50.0	18	1						•									
56.0	20	1							•								
61.5	22	1								•							
67.0	24	1									•						
73.0	26	1										•					
78.5	28	1											•				
85.0	30	1														•	
90.0	32	2					••										
95.0	34	2			•					•							
101.0	36	2					•		•								
106.5	38	2					•			•							
112.0	40	2					•				•						
118.0	42	2					•					•					
123.5	44	2					•						•				
130.0	46	2					•									•	
134.5	48	2								•		•					
140.0	50	2								•			•				
146.5	52	2								•						•	
151.5	54	2									•		•				
157.0	56	2											••				
163.5	58	2											•			•	
170.0	60	2														••	
175.0	62	3					••									•	
179.5	64	3					•			•		•					
185.0	66	3					•			•			•				
191.5	68	3					•			•						•	
196.5	70	3					•				•		•				
202.0	72	3					•						••				
208.5	74	3					•						•			•	
215.0	76	3					•									••	
218.5	78	3								•			••				
225.0	80	3								•			•			•	
231.5	82	3								•						••	
235.5	84	3											•••				
242.0	86	3											••			•	
248.5	88	3											•			••	
255.0	90	3														•••	

TVR Pro CO Series Engineering Data Book

Notes:

1. The combinations of units shown in the table are factory-recommended. Other combinations of units are also possible.
2. For systems with two or more outdoor units, outdoor branch joints (sold separately) are required.

4 Combination Ratio

$$\text{Combination ratio} = \frac{\text{Sum of capacity indexes of the indoor units}}{\text{Capacity index of the outdoor units}}$$

Table 1-4.1: Indoor and outdoor unit combination ratio limitations

Type	Minimum combination ratio	Maximum combination ratio		
		Standard indoor units only	Fresh air processing units only	Fresh air processing units and standard indoor units together
TVR Pro CO series ODU	50%	130% ¹	100%	100% ²

- Notes:
- The total capacity of the indoor units can be up to a maximum of 130% of the combined capacity of the outdoor unit for a system where not all the indoor units are operating at the same time.
 - When fresh air processing units are installed together with standard indoor units, the total capacity of the fresh air processing units must not exceed 30% of the total capacity of the outdoor units and the combination ratio must not exceed 100%.

Table 1-4.2: Combinations of Indoor and outdoor units

Outdoor unit capacity			Sum of capacity indexes of connected indoor units (standard indoor units only)	Sum of capacity indexes of connected indoor units (fresh air processing units and standard indoor units together)	Maximum number of connected indoor units
kW	HP	Capacity index			
22.4	8	224	112 to 291.2	112 to 224	13
28	10	280	140 to 364	140 to 280	16
33.5	12	335	167.5 to 435.5	167.5 to 335	20
40	14	400	200 to 520	200 to 400	23
45	16	450	225 to 585	225 to 450	26
50	18	500	250 to 650	250 to 500	29
56	20	560	280 to 728	280 to 560	33
61.5	22	615	307.5 to 799.5	307.5 to 615	36
67	24	670	335 to 871	335 to 670	39
73	26	730	365 to 949	365 to 730	43
78.5	28	785	392.5 to 1020.5	392.5 to 785	46
85	30	850	425 to 1105	425 to 850	50
90	32	900	450 to 1170	450 to 900	53
95	34	950	475 to 1235	475 to 950	56
101	36	1010	505 to 1313	505 to 1010	59
106.5	38	1065	532.5 to 1384.5	532.5 to 1065	63
112	40	1120	560 to 1456	560 to 1120	64
118	42	1180	590 to 1534	590 to 1180	
123.5	44	1235	617.5 to 1605.5	617.5 to 1235	
130	46	1300	650 to 1690	650 to 1300	
134.5	48	1345	672.5 to 1748.5	672.5 to 1345	
140	50	1400	700 to 1820	700 to 1400	
146.5	52	1465	732.5 to 1904.5	732.5 to 1465	
151.5	54	1515	757.5 to 1969.5	757.5 to 1515	
157	56	1570	785 to 2041	785 to 1570	
163.5	58	1635	817.5 to 2125.5	817.5 to 1635	
170	60	1700	850 to 2210	850 to 1700	
175	62	1750	875 to 2275	875 to 1750	
179.5	64	1795	897.5 to 2333.5	897.5 to 1795	
185	66	1850	925 to 2405	925 to 1850	
191.5	68	1915	957.5 to 2489.5	957.5 to 1915	
196.5	70	1965	982.5 to 2554.5	982.5 to 1965	
202	72	2020	1010 to 2626	1010 to 2020	
208.5	74	2085	1042.5 to 2710.5	1042.5 to 2085	
215	76	2150	1075 to 2795	1075 to 2150	
218.5	78	2185	1092.5 to 2840.5	1092.5 to 2185	
225	80	2250	1125 to 2925	1125 to 2250	
231.5	82	2315	1157.5 to 3009.5	1157.5 to 2315	
235.5	84	2355	1177.5 to 3061.5	1177.5 to 2355	
242	86	2420	1210 to 3146	1210 to 2420	
248.5	88	2485	1242.5 to 3230.5	1242.5 to 2485	
255	90	2550	1275 to 3315	1275 to 2550	

Part 2

Component Layout and Refrigerant Circuits

1	Layout of Functional Components	12
2	Piping Diagrams	15
3	Refrigerant Flow Diagrams	19

1 Layout of Functional Components

8-16HP

Figure 2-1.1: 8-16HP layout of functional components

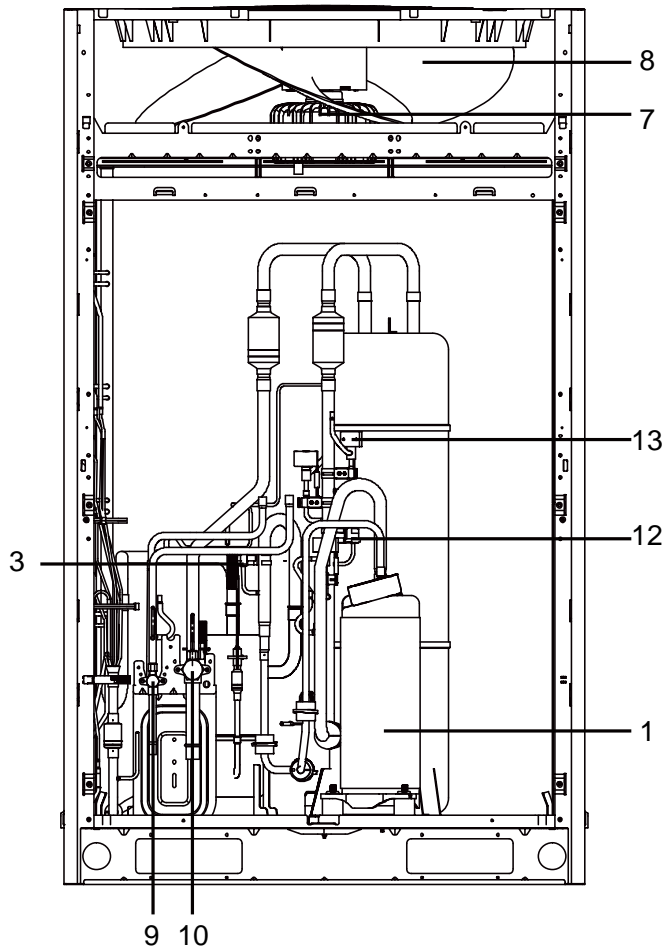
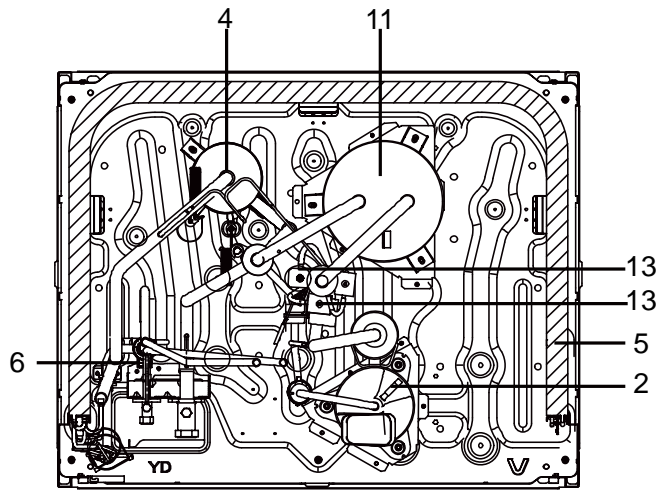

Legend	
No.	Parts name
1	Compressor
2	Discharge temperature sensor
3	High pressure sensor
4	Oil separator
5	Heat exchanger
6	Electronic expansion valve (EXV)
7	Fan motor
8	Fan
9	Stop valve (liquid side)
10	Stop valve (gas side)
11	Accumulator
12	Low pressure switch
13	Solenoid valve

18-22HP

Figure 2-1.2: 18-22HP layout of functional components

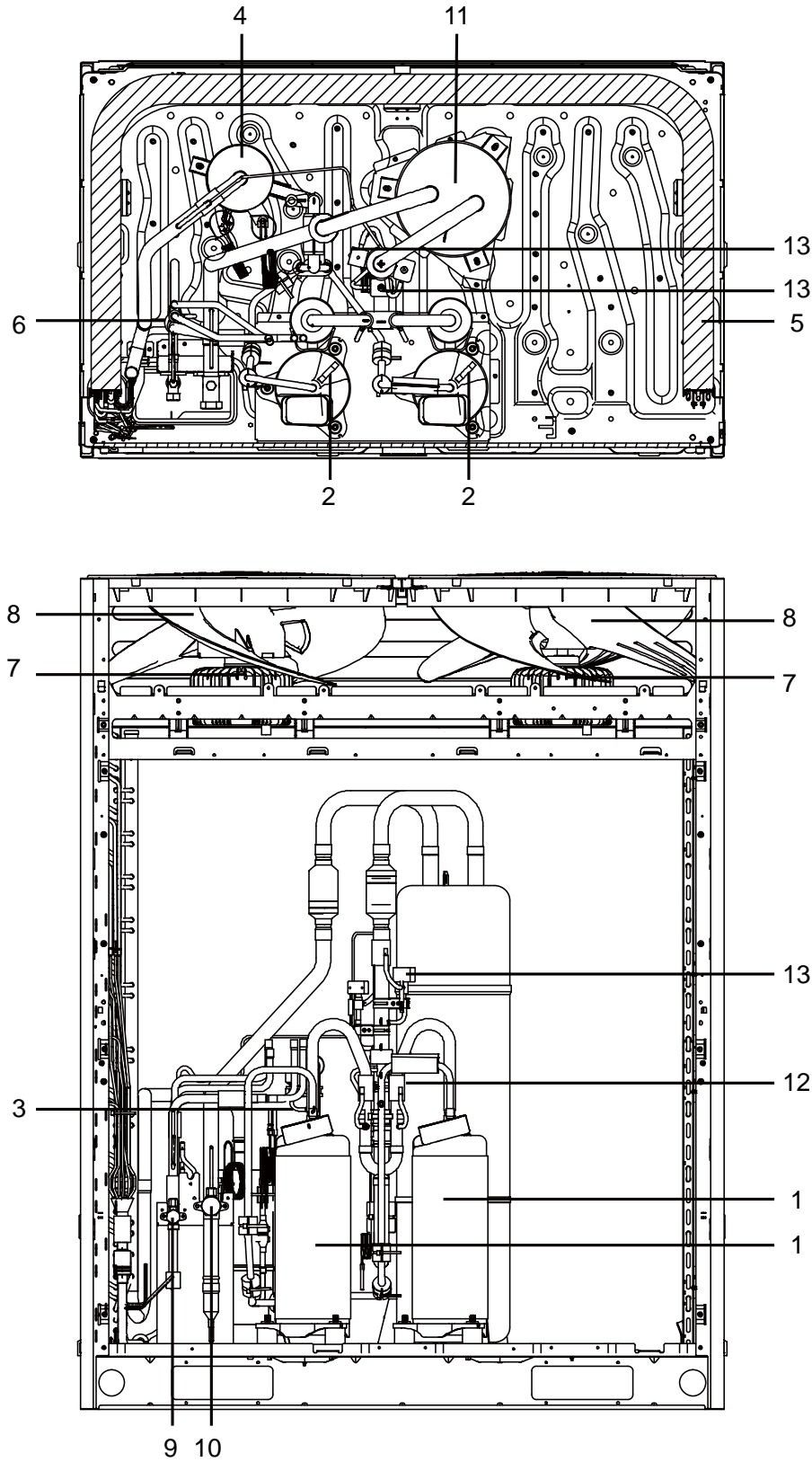

Legend	
No.	Parts name
1	Compressor
2	Discharge temperature sensor
3	High pressure sensor
4	Oil separator
5	Heat exchanger
6	Electronic expansion valve (EXV)
7	Fan motor
8	Fan
9	Stop valve (liquid side)
10	Stop valve (gas side)
11	Accumulator
12	Low pressure switch
13	Solenoid valve

TVR Pro CO 50/60Hz

24-30HP



Figure 2-1.3: 24-30HP layout of functional components

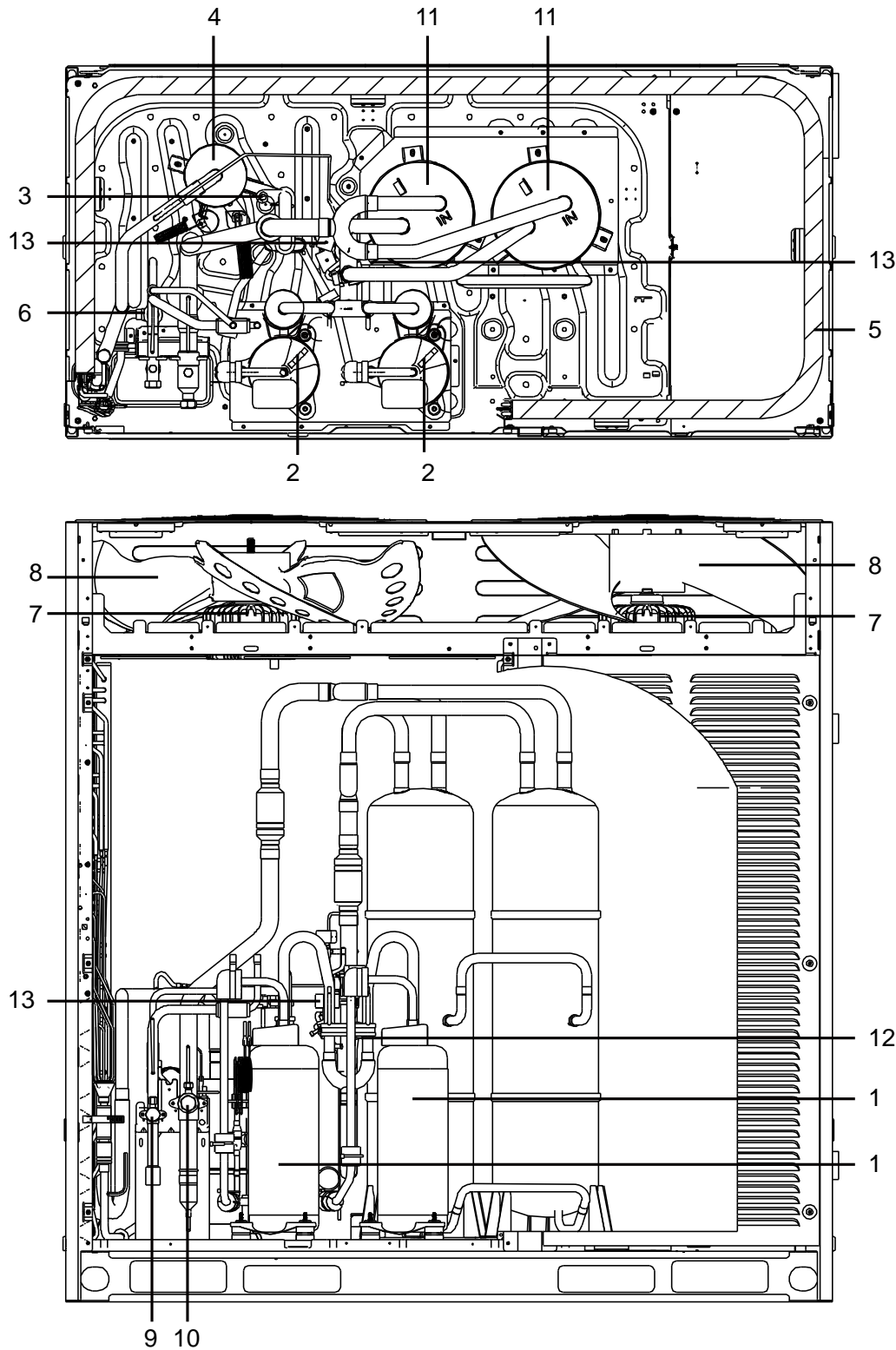

Legend	
No.	Parts name
1	Compressor
2	Discharge temperature sensor
3	High pressure sensor
4	Oil separator
5	Heat exchanger
6	Electronic expansion valve (EXV)
7	Fan motor
8	Fan
9	Stop valve (liquid side)
10	Stop valve (gas side)
11	Accumulator
12	Low pressure switch
13	Solenoid valve

TVR Pro CO Series Service Manual

2 Piping Diagrams

8-16HP

Figure 2-2.1: 8-16HP piping diagram

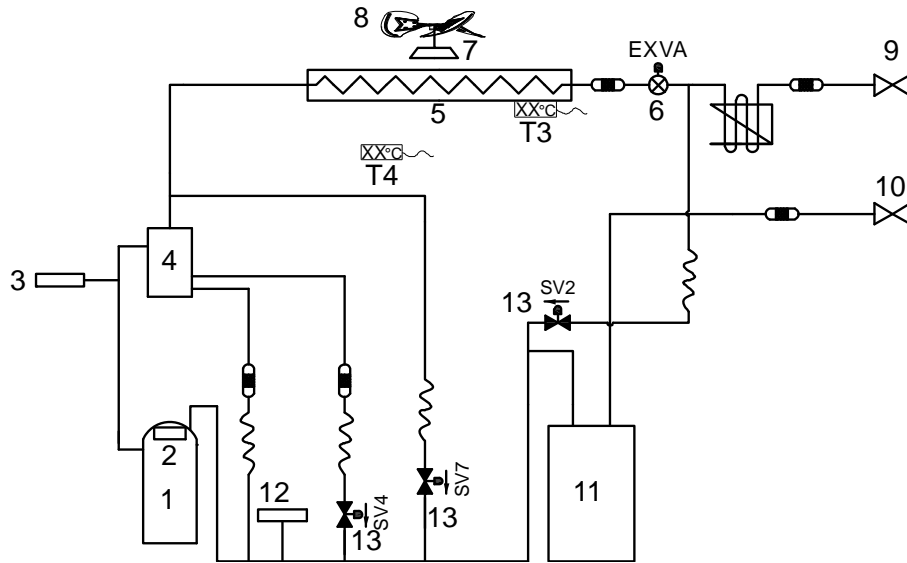

Legend			
No.	Parts name	No.	Parts name
1	Compressor	10	Stop valve (gas side)
2	Discharge temperature sensor	11	Accumulator
3	High pressure sensor	12	Low pressure switch
4	Oil separator	13	Solenoid valve
5	Heat exchanger	T3	Heat exchanger temperature sensor
6	Electronic expansion valve (EXV)	T4	Outdoor ambient temperature sensor
7	Fan motor	SV2	Liquid injection valve
8	Fan	SV4	Oil return valve
9	Stop valve (liquid side)	SV7	Pressure valve

TVR Pro CO 50/60Hz



18-22HP

Figure 2-2.2: 18-22HP piping diagram

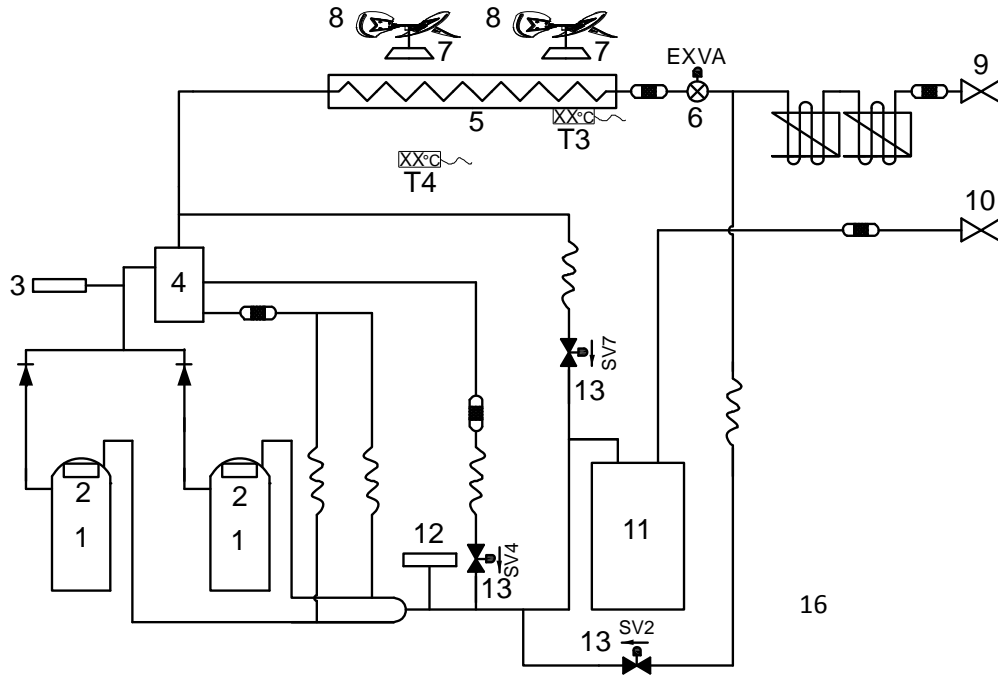

Legend			
No.	Parts name	No.	Parts name
1	Compressor	10	Stop valve (gas side)
2	Discharge temperature sensor	11	Accumulator
3	High pressure sensor	12	Low pressure switch
4	Oil separator	13	Solenoid valve
5	Heat exchanger	T3	Heat exchanger temperature sensor
6	Electronic expansion valve (EXV)	T4	Outdoor ambient temperature sensor
7	Fan motor	SV2	Liquid injection valve
8	Fan	SV4	Oil return valve
9	Stop valve (liquid side)	SV7	Pressure valve

24-30HP

Figure 2-2.3: 24-30HP piping diagram

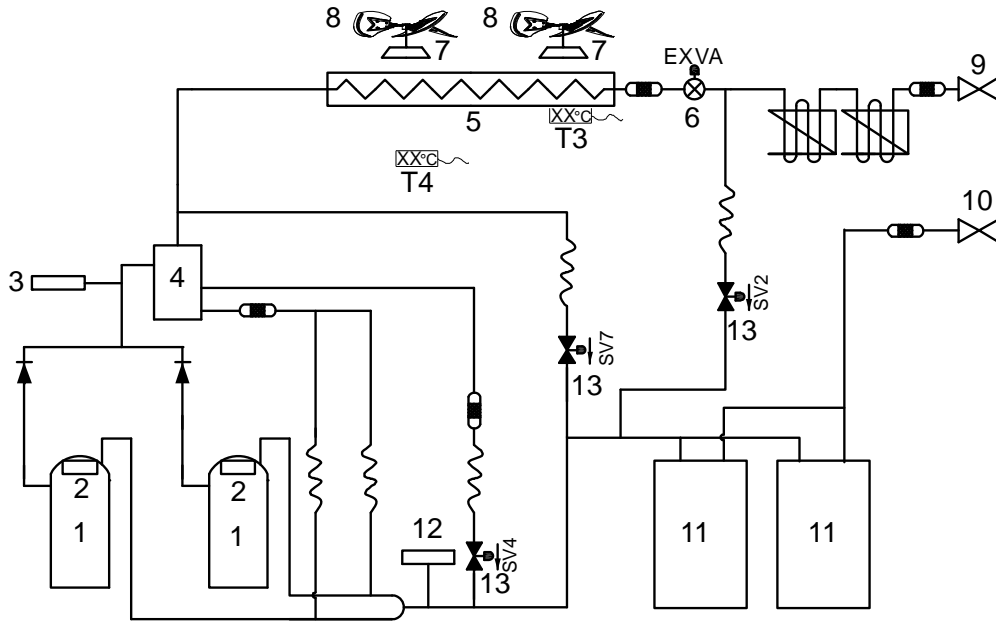

Legend			
No.	Parts name	No.	Parts name
1	Compressor	10	Stop valve (gas side)
2	Discharge temperature sensor	11	Accumulator
3	High pressure sensor	12	Low pressure switch
4	Oil separator	13	Solenoid valve
5	Heat exchanger	T3	Heat exchanger temperature sensor
6	Electronic expansion valve (EXV)	T4	Outdoor ambient temperature sensor
7	Fan motor	SV2	Liquid injection valve
8	Fan	SV4	Oil return valve
9	Stop valve (liquid side)	SV7	Pressure valve

Key components:

- 1. Oil separator:**

Separates oil from gas refrigerant pumped out of the compressor and quickly returns it to the compressor. Separation efficiency is up to 99%.
- 2. Accumulator:**

Stores liquid refrigerant and oil to protect compressor from liquid hammering.
- 3. Electronic expansion valve (EXV):**

Controls refrigerant flow and reduces refrigerant pressure.
- 4. Solenoid valve SV2:**

Protects the compressor. If compressor discharge temperature rises above 100°C, SV2 opens and sprays a small amount of liquid refrigerant to cool the compressor. SV2 closes again once the discharge temperature has fallen below 90°C.
- 5. Solenoid valve SV4:**

Returns oil to the compressor. Opens once the compressor has run for 200 seconds and closes 600 seconds later and then opens for 3 minutes every 20 minutes.
- 6. Solenoid valve SV7:**

Allows refrigerant to return directly to the compressor. Opens when indoor air temperature is close to the set temperature to avoid frequent compressor on/off. Opens when superheat degree is insufficient to avoid liquid hammer to compressor.
- 7. Low pressure switches:**

Regulate system pressure. When system pressure falls below the lower limit, the low pressure switches turn off, stopping the compressor. After 10 minutes, the compressor restarts.

3 Refrigerant Flow Diagrams

8-16HP

Cooling operation

Figure 2-3.1: 8-16HP refrigerant flow during cooling operation

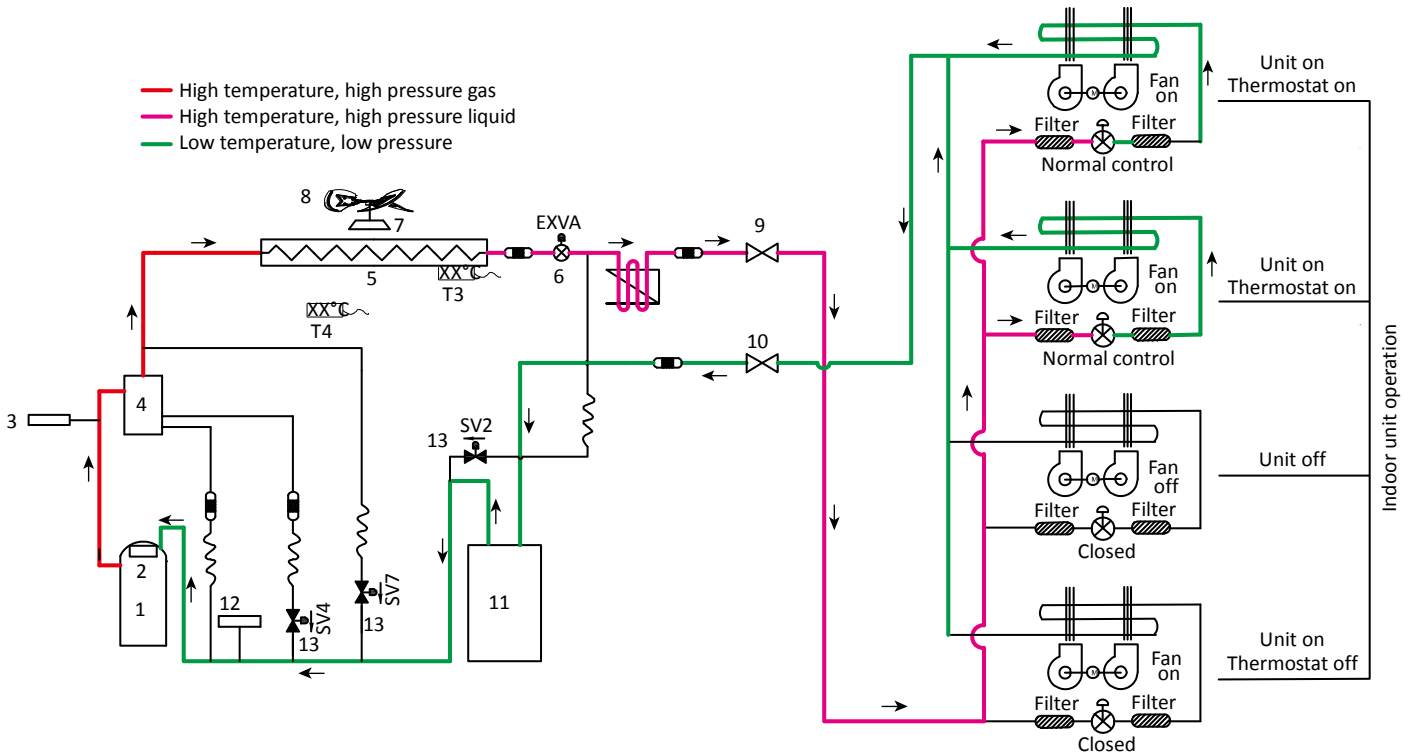

Oil return operation in cooling mode

Figure 2-3.2: 8-16HP refrigerant flow during oil return operation in cooling mode

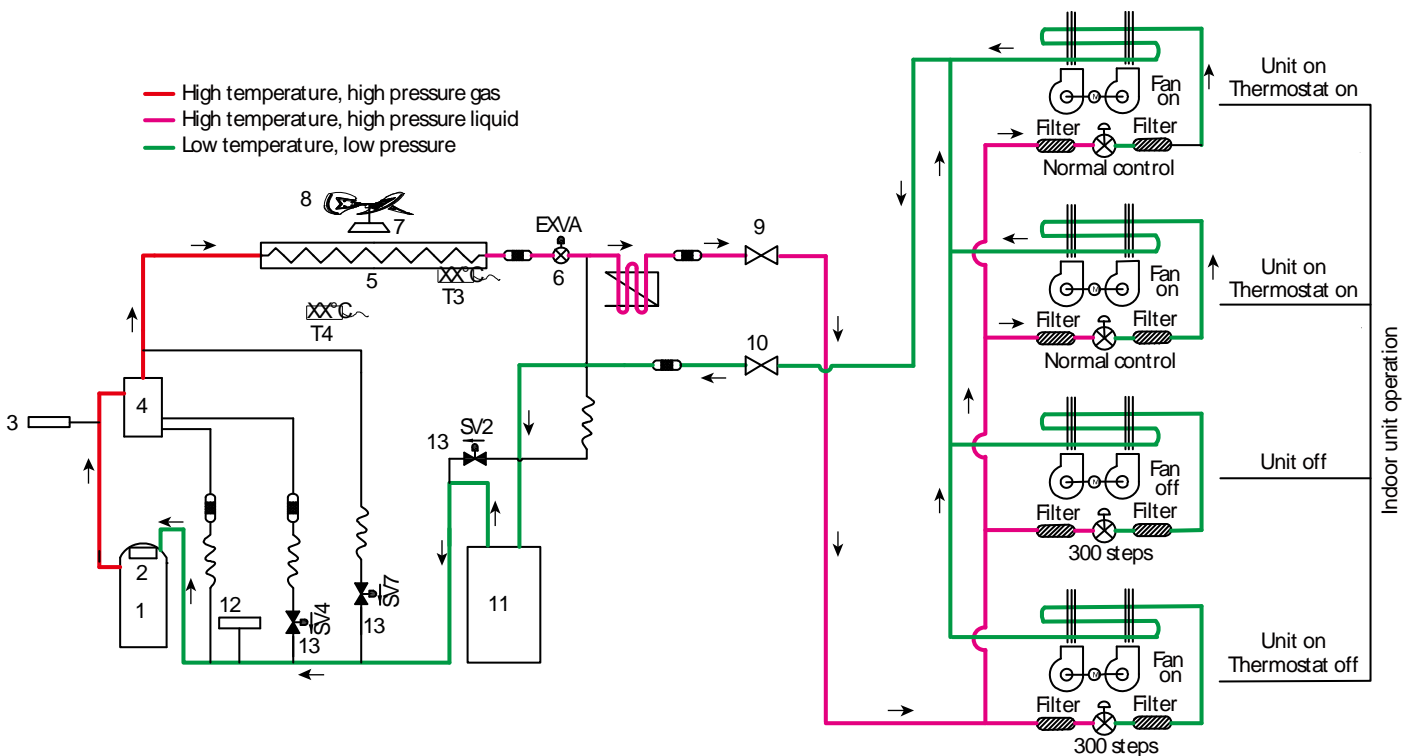

TVR Pro CO 50/60Hz



18-22HP

Cooling operation

Figure 2-3.3: 18-22HP refrigerant flow during cooling operation

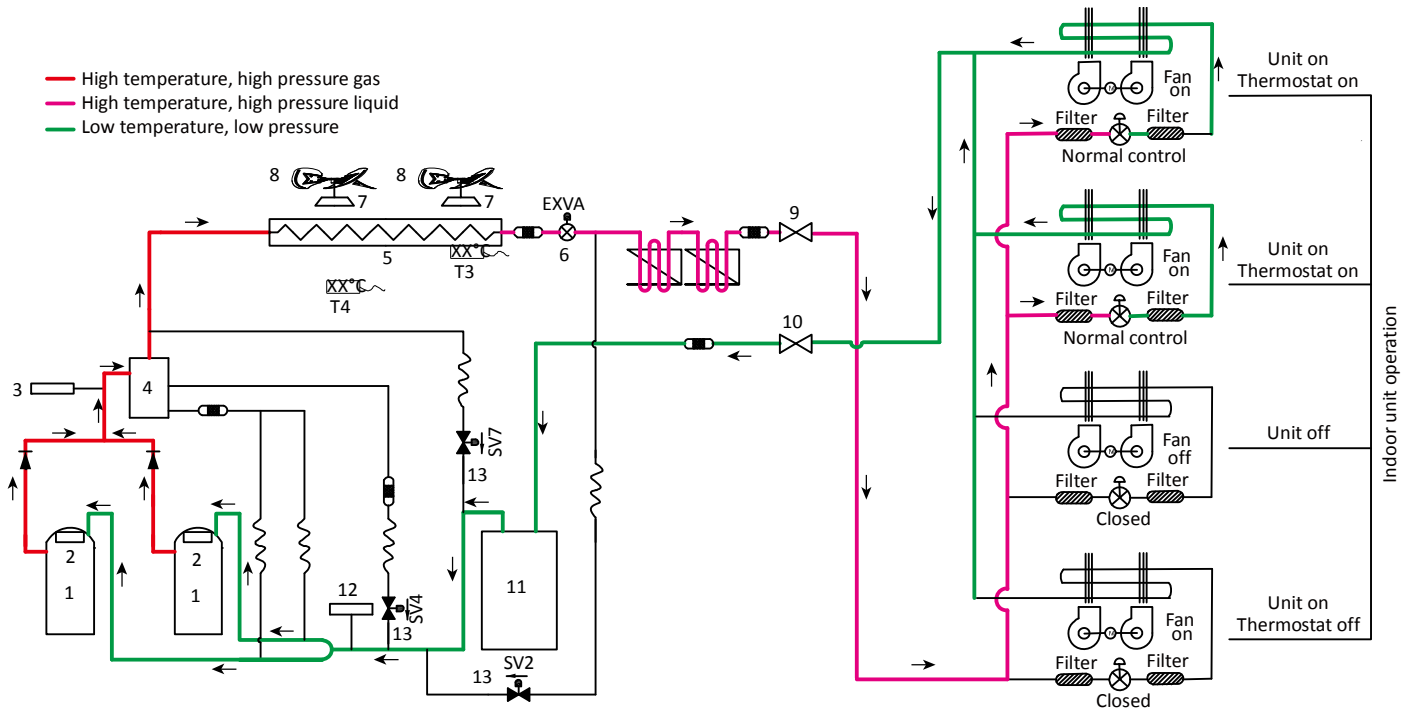

Oil return operation in cooling mode

Figure 2-3.4: 18-22HP refrigerant flow during oil return operation in cooling mode

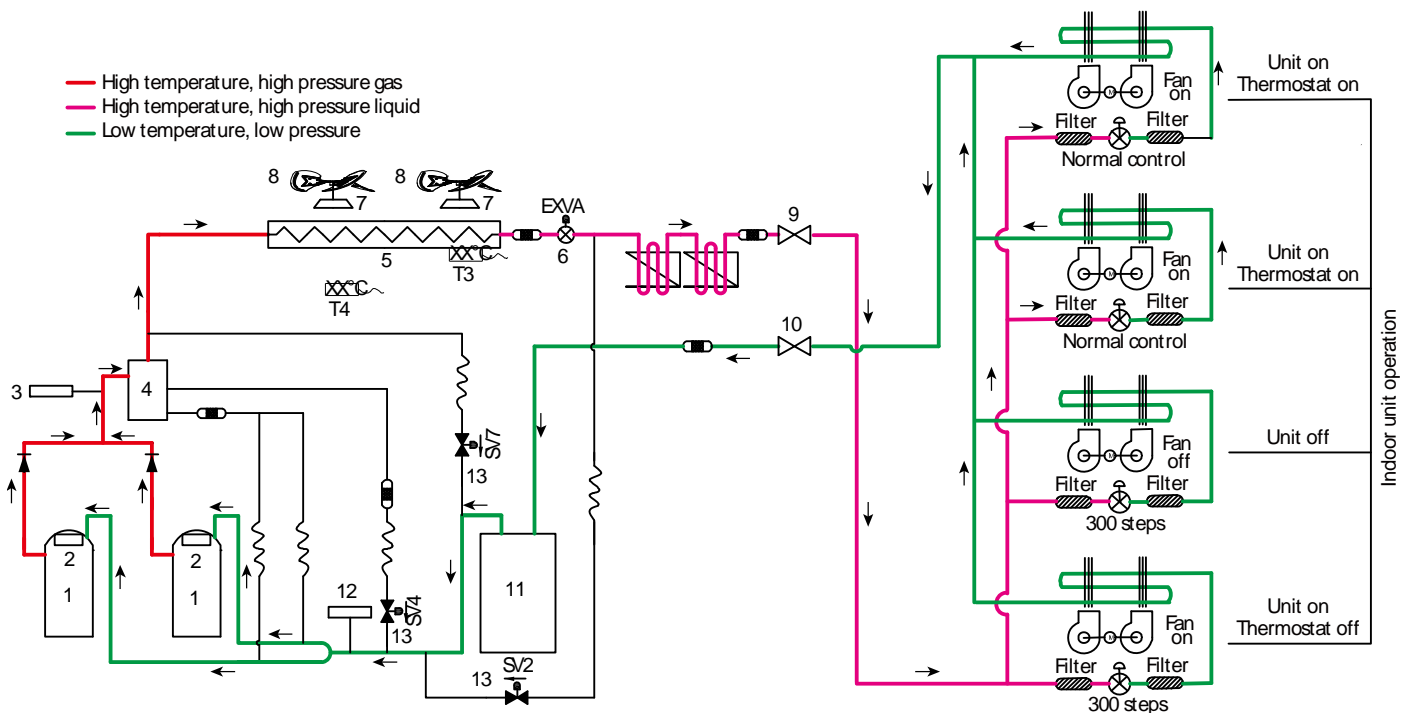

24-30HP

Cooling operation

Figure 2-3.5: 24-30HP refrigerant flow during cooling operation

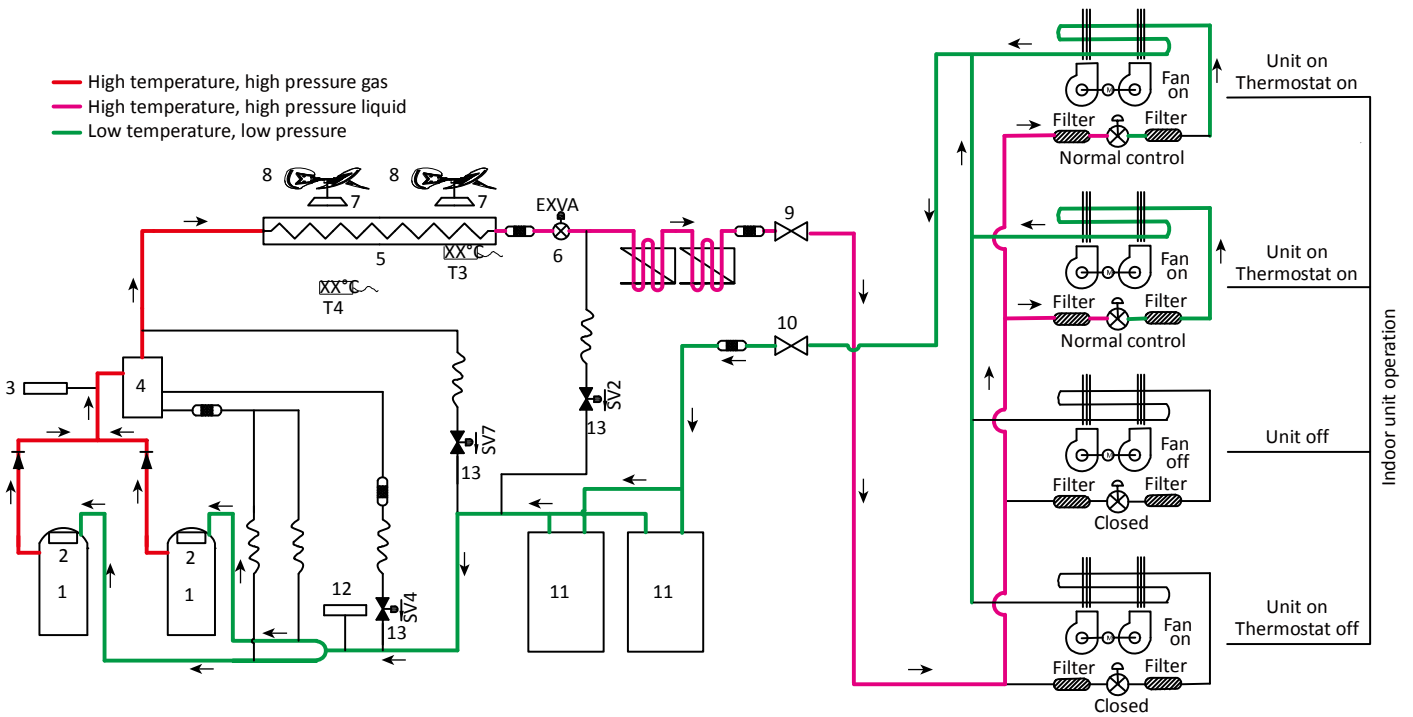

Oil return operation in cooling mode

Figure 2-3.6: 24-30HP refrigerant flow during oil return operation in cooling mode

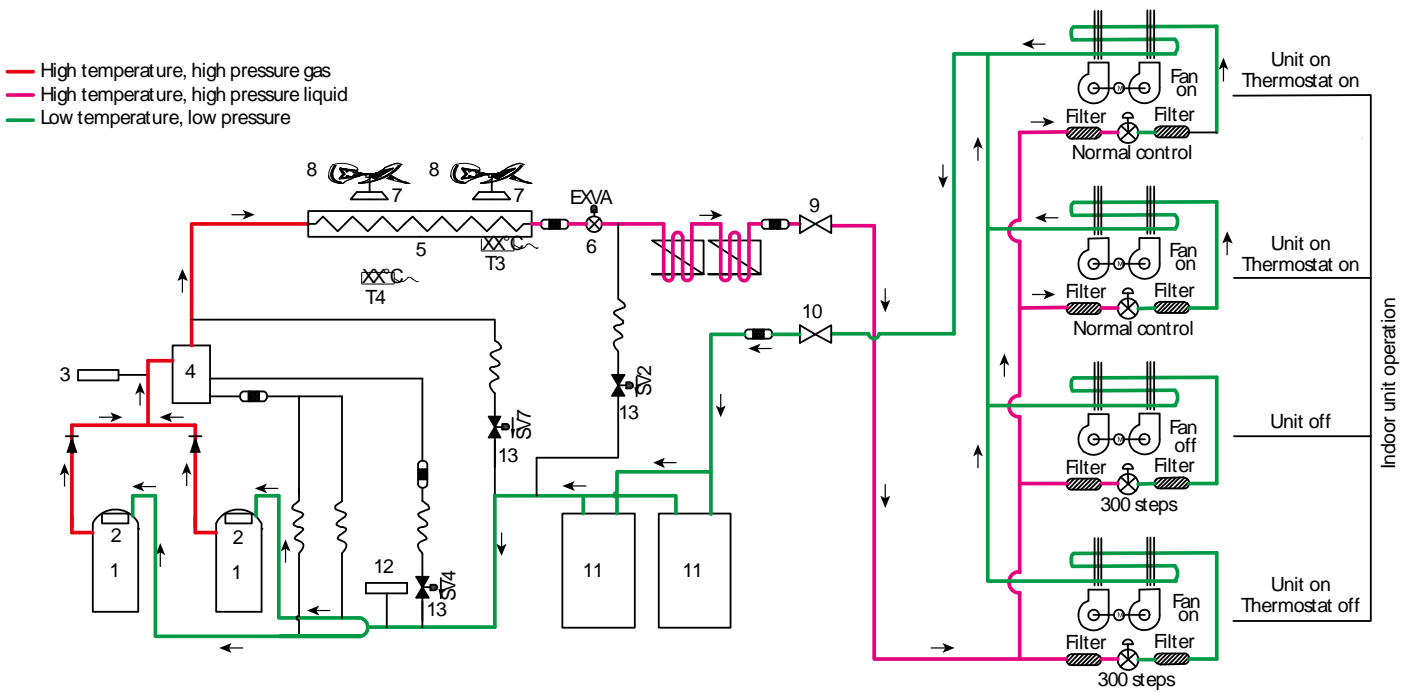

Part 3

Control

1 General Control Scheme Flowchart	24
2 Stop Operation.....	25
3 Startup Control	25
4 Normal Operation Control.....	26
5 Protection Control.....	29
6 Special Control	31

1 General Control Scheme Flowchart

Sections 3-2 to 3-6 on the following pages detail when each of the controls in the flowchart below is activated.

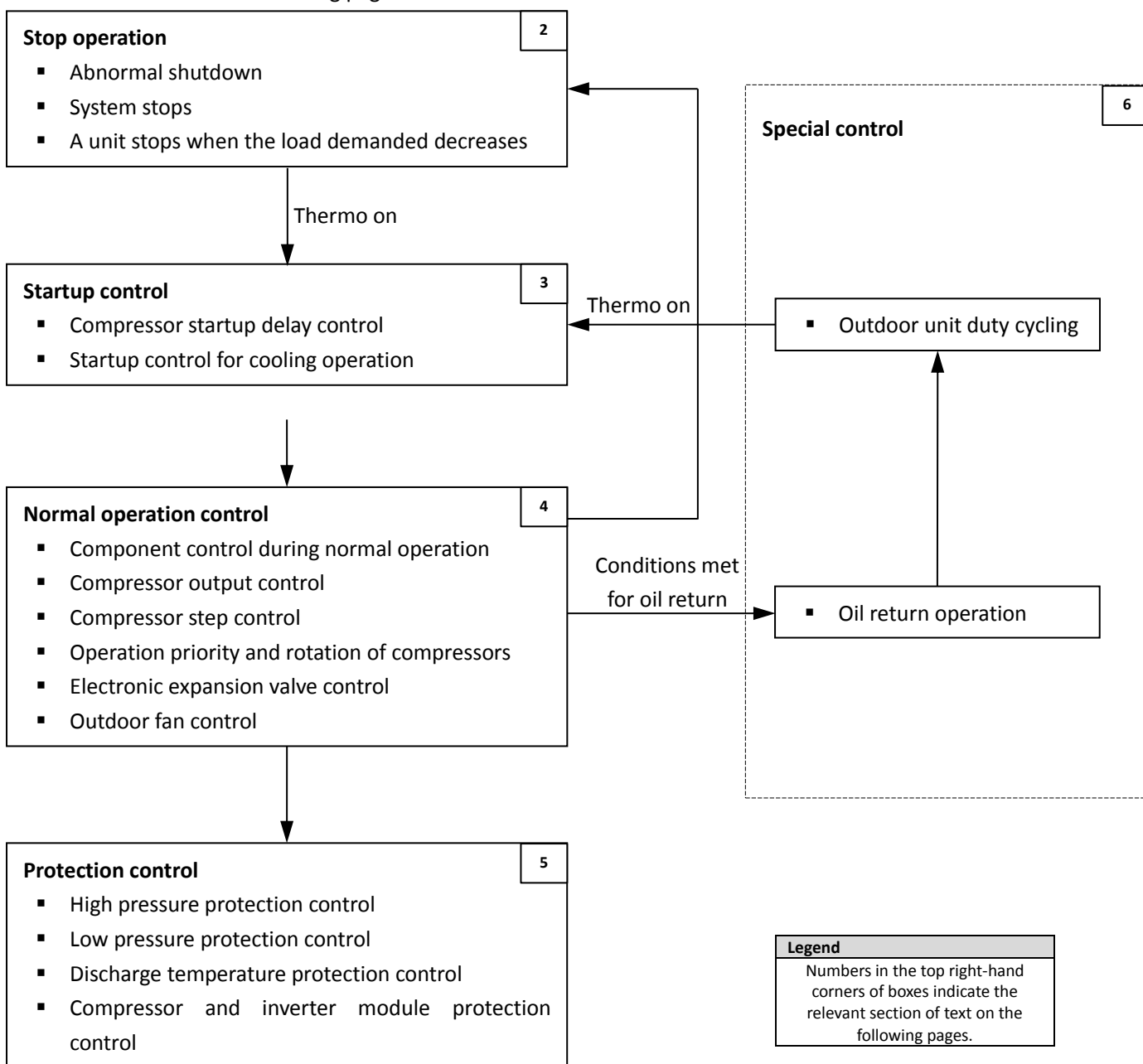

2 Stop Operation

The stop operation occurs for one of the three following reasons:

1. Abnormal shutdown: in order to protect the compressors, if an abnormal state occurs the system makes a 'stop with thermo off' operation and an error code is displayed on the outdoor unit digital displays.
2. The system stops when the set temperature has been reached.
3. A unit stops when the load demanded by the indoor units decreases and can be handled by fewer outdoor units.

3 Startup Control

3.1 Compressor Startup Delay Control

In initial startup control, compressor startup is delayed for 12 minutes in order to let the master unit search for the indoor units' addresses. In restart control (except in oil return operation), compressor startup is delayed such that a minimum of 7 minutes has elapsed since the compressor stopped, in order to prevent frequent compressor on/off and to equalize the pressure within the refrigerant system.

3.2 Startup Control for Cooling Operation

Table 3-3.1: Component control during startup in cooling mode

Component	Wiring diagram label	8-12HP	14-16HP	18-22HP	24-30HP	Control functions and states
Inverter compressor A	BP1	•	•	•	•	Controlled according to load requirement, operating frequency increased by 1 step / sec
Inverter compressor B	BP2			•	•	
DC fan motor A	FAN1	•	•	•	•	Fan speed controlled according to discharge pressure (P_c): <ul style="list-style-type: none"> ▪ At initial speed for 90 seconds. ▪ Subsequently, P_c checked every 10 seconds: <ul style="list-style-type: none"> • $P_c \geq 2.7\text{MPa} \Rightarrow$ 1 step increase. • $P_c \leq 2.1\text{MPa} \Rightarrow$ 1 step decrease.
DC fan motor B	FAN2			•	•	
Electronic expansion valve A	EXVA	•	•	•	•	Position (steps) from 0 (fully closed) to 3000 (fully open), controlled according to discharge temperature
Solenoid valve (Liquid injection)	SV2	•	•	•	•	Controlled according to discharge temperature
Solenoid valve (oil balance)	SV4	•	•	•	•	Closed for 200 secs, open for 600 secs, then closed
Solenoid valve (refrigerant bypass)	SV7	•	•	•	•	Controlled according to load requirement and discharge pressure

4 Normal Operation Control

4.1 Component Control during Normal Operation

Table 3-4.1: Component control during normal cooling operation

Component	Wiring diagram label	8-12HP	14-16HP	18-22HP	24-30HP	Control functions and states
Inverter compressor A	BP1	•	•	•	•	Controlled according to load requirement
Inverter compressor B	BP2			•	•	
DC fan motor A	FAN1	•	•	•	•	Controlled according to discharge pressure
DC fan motor B	FAN2			•	•	
Electronic expansion valve A	EXVA	•	•	•	•	Position (steps) from 0 (fully closed) to 3000 (fully open), controlled according to discharge temperature
Solenoid valve (Liquid injection)	SV2	•	•	•	•	Controlled according to discharge temperature
Solenoid valve (oil balance)	SV4	•	•	•	•	Open regularly
Solenoid valve (refrigerant bypass)	SV7	•	•	•	•	Controlled according to ambient temperature, discharge pressure, compressor running frequency, discharge superheating degree, load requirement, discharge temperature and discharge pressure.

4.2 Compressor Output Control

The compressor rotation speed is controlled according to the load requirement. Before compressor startup, the outdoor units first estimate the indoor unit load requirement according to the nominal capacity of indoor units currently running, and then correct for ambient temperature. The compressors then start up according to the corrected load requirement.

During operation the compressors are controlled according to the nominal capacity of indoor units currently running and the indoor unit heat exchanger temperatures. If the actual load requirement can be provided by one unit alone, then only one unit starts up. If the actual load requirement requires all outdoor unit modules to operate, the weighted average actual load requirement is sent to each module and each module operates according to this distributed load requirement.

4.3 Compressor Step Control

The compressor speed can be altered in increments of 1 rps (rotations per second) and decrease of 2rps.

4.4 Operating Priority and Rotation of Compressors

Figures 3-4.1 to 3-4.3 show the compressor operating priority and rotation in systems with one, two and three outdoor units. In units with two compressors, inverter compressor A (BP1) operates in priority to inverter compressor B (BP2). In multi-unit systems, units operate in rotation. In Figures 3-4.2 and 3-4.3 the master unit and slave units 1 and 2 are shown from left to right in that order, and the circled numbers (①, ②, ③) indicate the rotation sequence.

Figure 3-4.1: Compressor priority and rotation – one outdoor unit



Figure 3-4.2: Compressor priority and rotation – two outdoor units

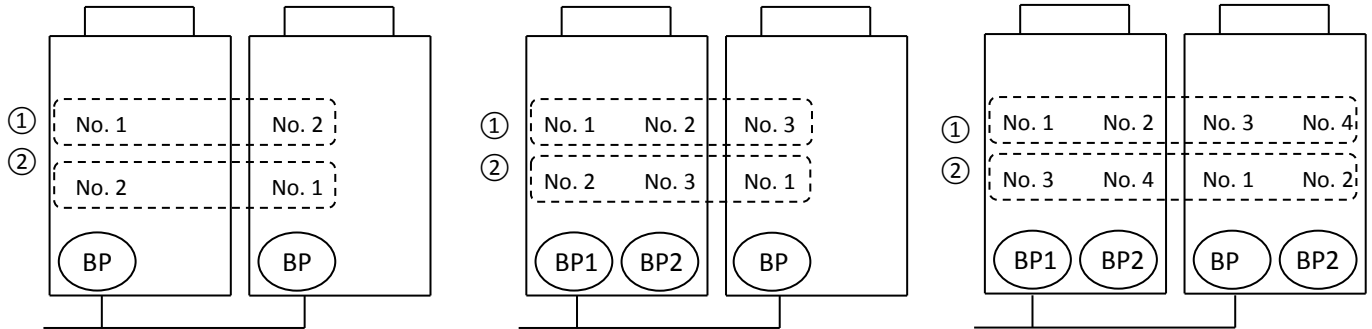
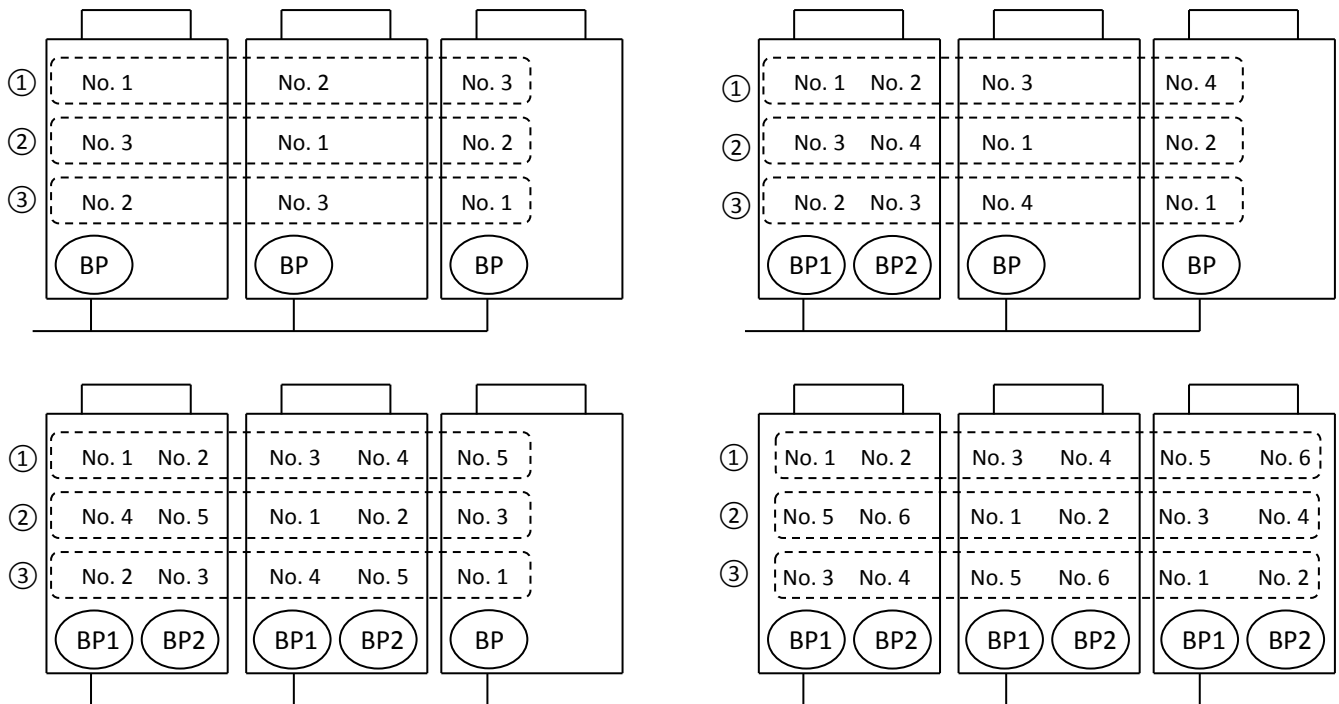

Figure 3-4.3: Compressor priority and rotation – three outdoor units



4.5 Electronic Expansion Valve Control

EXVA control

The position of electronic expansion valve EXVA is controlled in steps from 0 (fully closed) to 3000 (fully open).

In cooling mode:

- When all outdoor units are in standby:
 - All EXVAs are at position 352×6 (steps).
- When some outdoor units are running and some outdoor units are in standby:
 - EXVAs on running outdoor units are controlled according to discharge temperature. EXVAs of units in standby are

fully closed.

- When all outdoor units are running:
 - All EXVAs are controlled according to discharge temperature.

4.6 Outdoor Fan Control

The speed of the outdoor unit fans is adjusted in steps, as shown in Table 3-4.2.

Table 3-4.2: Outdoor fan speed steps

Fan speed index	Fan speed (rpm)		
	8-16HP	18-22HP	24-30HP
		FANA / FANB	FANA / FANB
0	0	0 / 0	0 / 0
1	120	150 / 0	120 / 0
2	150	190 / 0	150 / 0
3	170	230 / 0	170 / 0
4	190	270 / 0	190 / 0
5	210	310 / 0 (150 / 150)	210 / 0
6	230	350 / 0 (180 / 180)	230 / 0
7	250	380 / 0 (210 / 210)	250 / 0 (120 / 120)
8	270	410 / 0 (240 / 240)	270 / 0 (150 / 150)
9	290	280 / 280	330 / 0 (170 / 170)
10	310	320 / 320	370 / 0 (190 / 190)
11	330	360 / 360	210 / 210
12	350	400 / 400	230 / 230
13	370	440 / 440	250 / 250
14	390	480 / 480	270 / 270
15	410	520 / 520	290 / 290
16	430	560 / 560	310 / 310
17	450	600 / 600	330 / 330
18	470	640 / 640	350 / 350
19	490	680 / 680	370 / 370
20	510	720 / 720	400 / 400
21	530	750 / 750	430 / 430
22	560	780 / 780	470 / 470
23	580	800 / 800	510 / 510
24	600	840 / 840	550 / 550
25	630	880 / 880	600 / 600
26	650	910 / 880	650 / 650
27	700	910 / 910	680 / 680
28	750	940 / 910	700 / 700
29	800	940 / 940	750 / 750
30	850	980 / 940	780 / 780
31	880	980 / 980	800 / 800
32	910	1000 / 980	830 / 830
33	930	1000 / 1000	850 / 850
34	960	1020 / 1000	870 / 870
35	1000	1020 / 1020	890 / 890
36	1050	1050 / 1050	920 / 920
37	1100	1100 / 1100	950 / 950

Note:

1. For 18-22HP unit fan speed 5 to 8 and 24-30HP unit fan speed 7 to 10, when fan speed decreases, the fan speed is shown in the bracket; when fan speed increases, the fan speed is shown without bracket.

5 Protection Control

5.1 High Pressure Protection Control

This control protects the system from abnormally high pressure and protects the compressors from transient spikes in pressure.

Figure 3-5.1: High pressure protection control

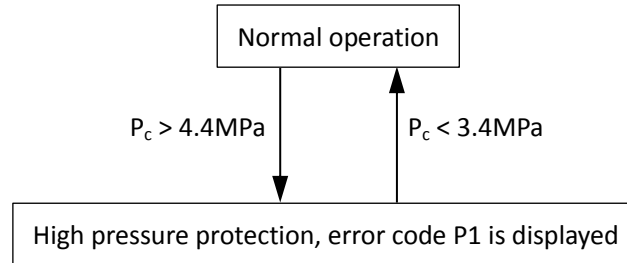

Notes:

1. P_c : Discharge pressure

5.2 Low Pressure Protection Control

This control protects the system from abnormally low pressure and protects the compressors from transient drops in pressure.

Figure 3-5.2: Low pressure protection control

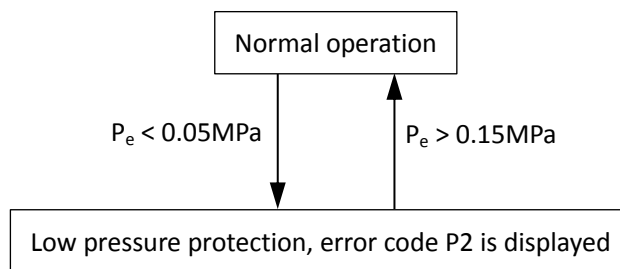

Notes:

1. P_e : Suction pressure

When P2 protection occurs 3 times in 60 minutes, the H5 error is displayed. When an H5 error occurs, a manual system restart is required before the system can resume operation.

5.3 Discharge Temperature Protection Control

This control protects the compressors from abnormally high temperatures and transient spikes in temperature. It is performed for each compressor.

Figure 3-5.3: Discharge temperature protection control

Discharge temperature

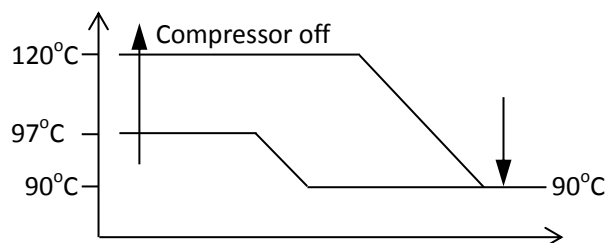

When the discharge temperature rises above 120°C the system displays P4 protection and all units stop running. When P4 protection occurs 3 times in 100 minutes, the H6 error is displayed. When an H6 error occurs, a manual system restart is required before the system can resume operation.

5.4

5.5 Compressor and Inverter Module Protection Control

This control protects the compressors from abnormally high currents and protects the inverter modules from abnormally high temperatures. It is performed for each compressor and inverter module.

Figure 3-5.4: Compressor current protection control

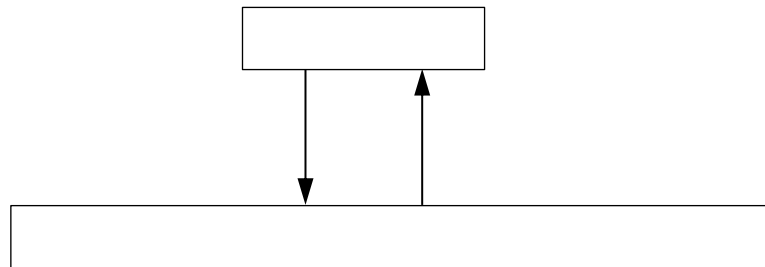

Compressor model	LNB53	LNB65
Current _{max}	48.5	59

Figure 3-5.5: Inverter module temperature protection control

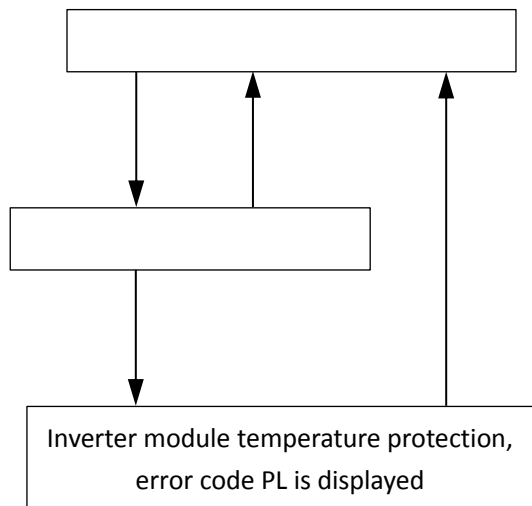

When PL protection occurs 3 times in 100 minutes, the C7 error is displayed. When a C7 error occurs, a manual system restart is required before the system can resume operation.

- Notes:
1. T_f : Heat sink temperature

6 Special Control

6.1 Outdoor Unit Duty Cycling

In systems with multiple outdoor units, outdoor unit duty cycling is used to prevent compressor burn out due to unbalanced oil levels between outdoor units.

Timing of outdoor unit duty cycling:

- After oil return operation.
- On restart following compressor stop after set temperatures achieved.

Figure 3-6.1 shows an example of duty cycling in a system with 3 outdoor units.

Figure 3-6.1: Duty cycling in a system with 3 outdoor units¹

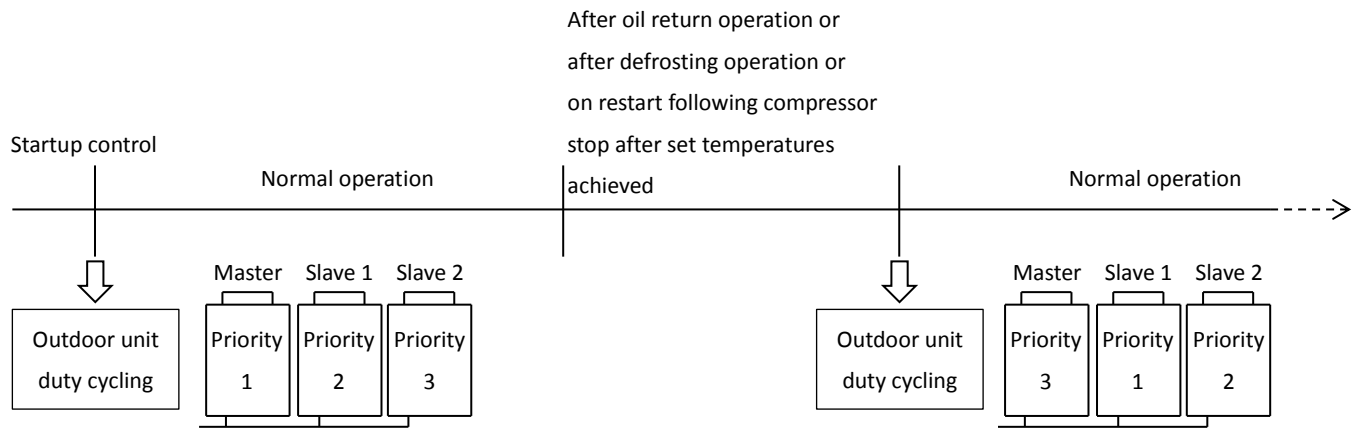

Notes:

1. The address settings on the outdoor unit main PCBs for “master unit”, “slave unit 1”, and “slave unit 2” do not change.

6.2 Oil Return Operation

In order to prevent compressors from running out of oil, the oil return operation is conducted to recover oil that has flowed out of the compressor(s) and into the piping system. This operation is performed for all units including units that are in standby. When the outdoor unit is running in oil return, the digital display on outdoor main PCB will display “d0”.

Timing of oil return operation:

- When the initial cumulative operating time reaches 140 minutes and then every 8 hours.

Tables 3-6.1 and 3-6.2 show component control during oil return operation in cooling mode.

Table 3-6.1: Outdoor unit component control during oil return operation in cooling mode

Component	Wiring diagram label	8-12HP	14-16HP	18-22HP	24-30HP	Control functions and states
Inverter compressor A	BP1	●	●	●	●	Fixed frequency
Inverter compressor B	BP2			●	●	
DC fan motor A	FAN1	●	●	●	●	Controlled according to discharge pressure
DC fan motor B	FAN2			●	●	
Electronic expansion valve A	EXVA	●	●	●	●	Position 480 (steps)
Solenoid valve (Liquid injection)	SV2	●	●	●	●	Normal control
Solenoid valve (oil balance)	SV4	●	●	●	●	Normal control
Solenoid valve (refrigerant bypass)	SV7	●	●	●	●	Normal control

Table 3-6.2: Indoor unit component control during oil return operation in cooling mode

Component	Unit state	Control functions and states
Fan	Thermo on	Remote controller setting
	Standby	Off
	Thermo off	Off
Electronic expansion valve	Thermo on	Normal control
	Standby	300 (steps)
	Thermo off	300 (steps)

Part 4

Field Settings

1	Outdoor Unit Field Settings	34
---	-----------------------------------	----

1 Outdoor Unit Field Settings

1.1 PCB Switches and Switch Settings

Figure 4-1.1: Outdoor unit main PCB switches

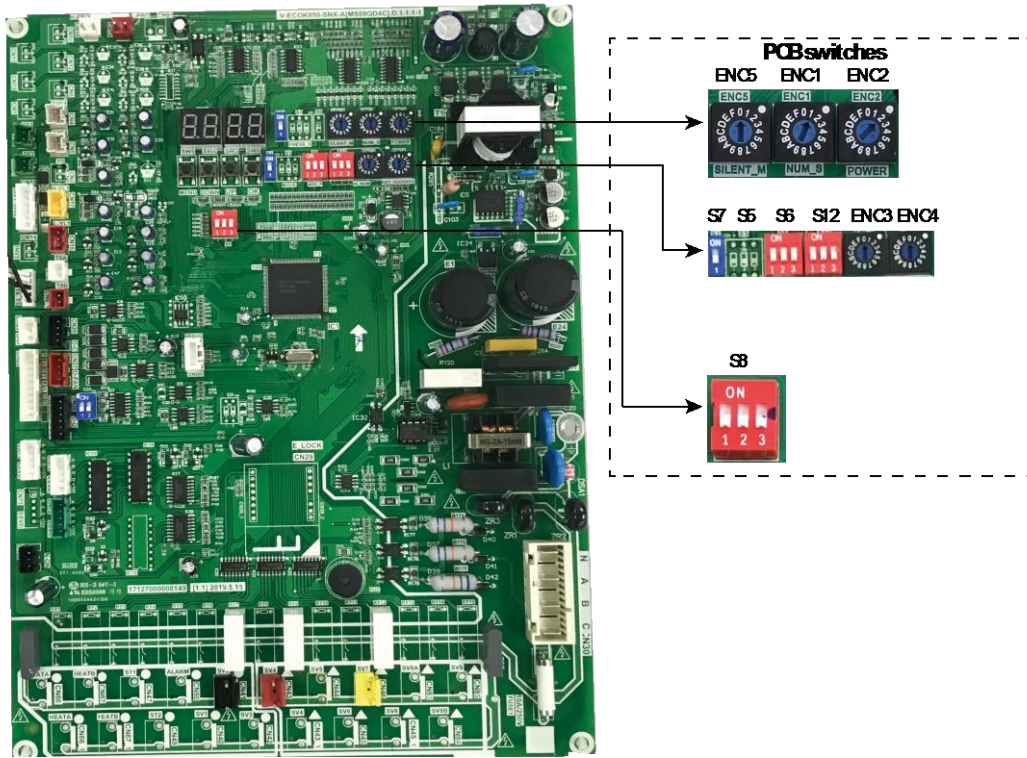

Table 4-1.1: Outdoor unit main PCB switch settings

Switch	Setting	Switch positions ¹	Description
S5	Reserved		
S6-1	Reserved	ON	Reserved
S6-2	Clear indoor unit addresses	ON	No action (default)
		ON	Clear indoor unit addresses
S6-3	Addressing mode	ON	Auto addressing (default)
		ON	Manual addressing
S8-1	Reserved	ON	Reserved
S8-2	Start-up time	ON	Start-up time is 12 minutes (default)
		ON	Start-up time is 7 minutes
S8-3	Reserved	ON	Reserved
S7	Reserved		
S9	Reserved		
ENC1	Outdoor unit address		Only 0, 1, 2 should be selected (default is 0) 0 is for master unit; 1 and 2 are for slave units
ENC2	Outdoor unit capacity ²		Only 0, 1, 2, 3, 4, 5, 6, 7, 8, 9, A, B should be selected 0: 8HP; 1: 10HP; 2: 12HP; 3: 14HP; 4: 16HP; 5: 18HP; 6: 20HP; 7: 22HP; 8: 24HP; 9: 26HP; A: 28HP; B:30HP
ENC4	Network address		Only 0, 1, 2, 3, 4, 5, 6, 7 should be selected (default is 0)

Table continued on next page ...

Table 4-1.1: Outdoor unit main PCB switch settings (continued)

Switch	Setting	Switch positions ¹	Description
ENC3 S12 	Number of indoor units		The number of indoor units is in the range 0-15 0-9 on ENC3 indicate 0-9 indoor units; A-F on ENC3 indicate 10-15 indoor units
			The number of indoor units is in the range 16-31 0-9 on ENC3 indicate 16-25 indoor units; A-F on ENC3 indicate 26-31 indoor units
			The number of indoor units is in the range 32-47 0-9 on ENC3 indicate 32-41 indoor units; A-F on ENC3 indicate 42-47 indoor units
			The number of indoor units is in the range 48-63 0-9 on ENC3 indicate 48-57 indoor units; A-F on ENC3 indicate 58-63 indoor units
			The number of indoor units is 64 0 on ENC3 indicate 64 indoor units
ENC5 	Silent mode ³	0	Night silent time is 6h/10h (default)
		1	Night silent time is 6h/12h
		2	Night silent time is 8h/10h
		3	Night silent time is 8h/12h
		4	No silent mode
		5	Silent mode 1 (only limit max. fan speed)
		6	Silent mode 2 (only limit max. fan speed)
		7	Silent mode 3 (only limit max. fan speed)
		8	Super silent mode 1 (limit max. fan speed and compressor frequency)
		9	Super silent mode 2 (limit max. fan speed and compressor frequency)
A	Super silent mode 3 (limit max. fan speed and compressor frequency)		
B	Super silent mode 4 (limit max. fan speed and compressor frequency)		
F	Set silent mode via centralized controller		

Notes:

1. Black denotes the switch position.
2. Switch ENC2 is factory-set and its setting should not be changed.
3. Refer to Part 4, 1.2.1 "Silent mode setting".

1.2 Modes Set on Main PCB

1.2.1 Silent time setting

1.2.1.1 Night silent time setting

Night silent mode is activated X hours after the peak daytime temperature, and is deactivated after Y hours, where X and Y are as specified in Table 4-1.2.

Table 4-1.2: Night silent time setting

Switch	Switch positions	Description	X	Y
	0	Night silent time is 6h/10h (default)	6	10
	1	Night silent time is 6h/12h	6	12
	2	Night silent time is 8h/10h	8	10
	3	Night silent time is 8h/12h	8	12

Figure 4-1.4: Night silent mode example (default setting, 6h/10h)

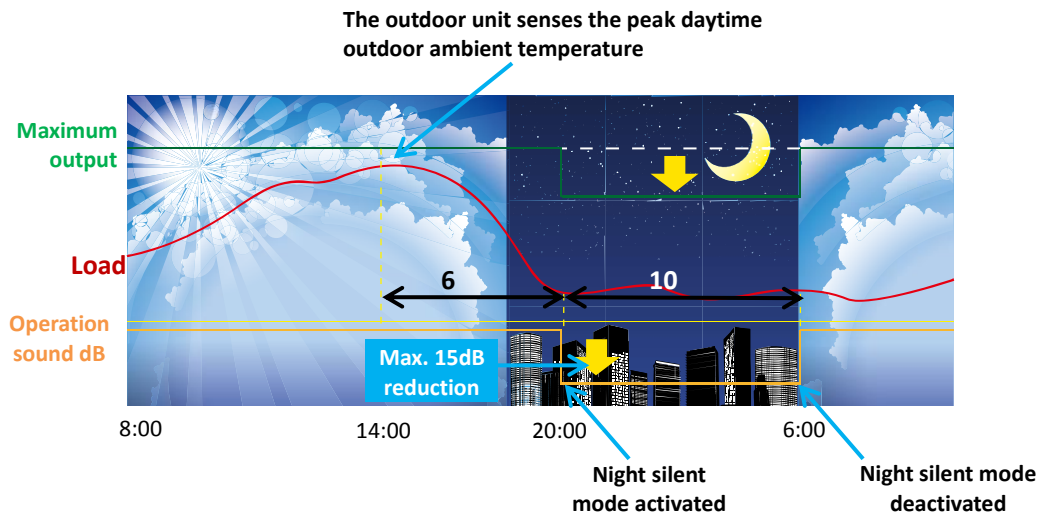

1.2.1.2 Silent mode setting

In silent mode 1 / 2 / 3 and night silent mode, the outdoor fan speed decreases gradually. In super silent mode 1 / 2 / 3 / 4, not only the fan speed decreases gradually, but also the compressor frequency decreases gradually.

Table 4-1.3: Silent mode setting

Switch	Switch positions	Description
 ENC5	5	Silent mode 1 (only limit max. fan speed)
	6	Silent mode 2 (only limit max. fan speed)
	7	Silent mode 3 (only limit max. fan speed)
	8	Super silent mode 1 (limit max. fan speed and compressor frequency)
	9	Super silent mode 2 (limit max. fan speed and compressor frequency)
	A	Super silent mode 3 (limit max. fan speed and compressor frequency)
	B	Super silent mode 4 (limit max. fan speed and compressor frequency)

1.2.1.3 Maximum fan speed and capacity output control in different silent mode

Table 4-1.4: Maximum fan speed and capacity output control in different silent mode

ENC5 Switch positions	Description	Max. fan speed index ¹							Max. capacity output
		8-10HP	12HP	14-16HP	18HP	20-22HP	24-26HP	28-30HP	8-30HP
0	Night silent time is 6h/10h (default)	28	28	30	29	29	31	31	100%
1	Night silent time is 6h/12h								
2	Night silent time is 8h/10h								
3	Night silent time is 8h/12h								
4	No silent mode	29	30	33	33	35	33	35	
5	Silent mode 1	28	28	30	31	31	31	31	
6	Silent mode 2	26	26	28	29	29	29	29	
7	Silent mode 3	24	24	27	27	27	27	27	
8	Super silent mode 1	28	28	29	23	23	28	28	80%
9	Super silent mode 2	27	27	28	22	22	27	27	70%
A	Super silent mode 3	26	26	27	21	21	26	26	60%
B	Super silent mode 4	25	25	26	20	20	25	25	50%

Notes:

1. Fan speed (rpm) for different fan speed index refers to Table 3-4.2 in Part 3, 4.6 "Outdoor Fan Control".
2. If the system pressure is over 3.5MPa, the system exits silent mode automatically.

Part 5

Electrical Components and Wiring Diagrams

1	Outdoor Unit Electric Control Box Layout	40
2	Outdoor Unit Main PCB.....	42
3	Wiring Diagrams.....	51

1 Outdoor Unit Electric Control Box Layout

8-16HP

Figure 5-1.1: 8-16HP top layer of electric control box

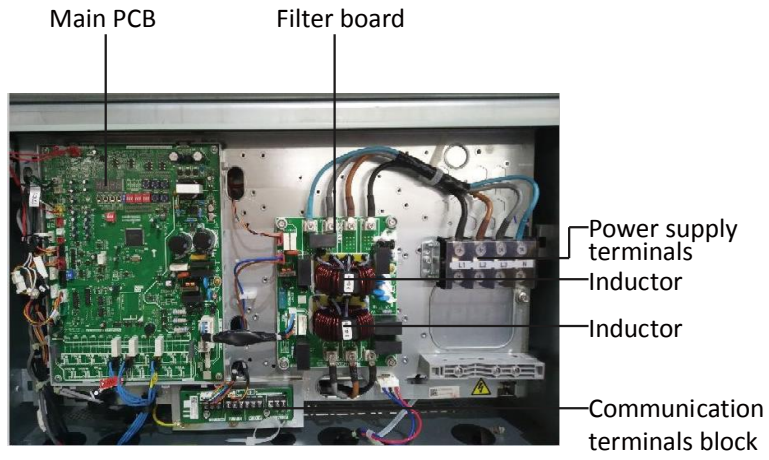

Figure 5-1.2: 8-16HP bottom layer of electric control box

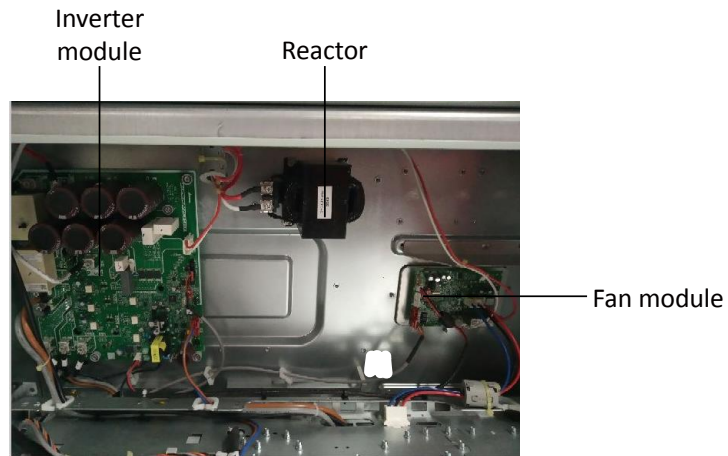

Figure 5-1.3: 18-30HP top layer of electric control box

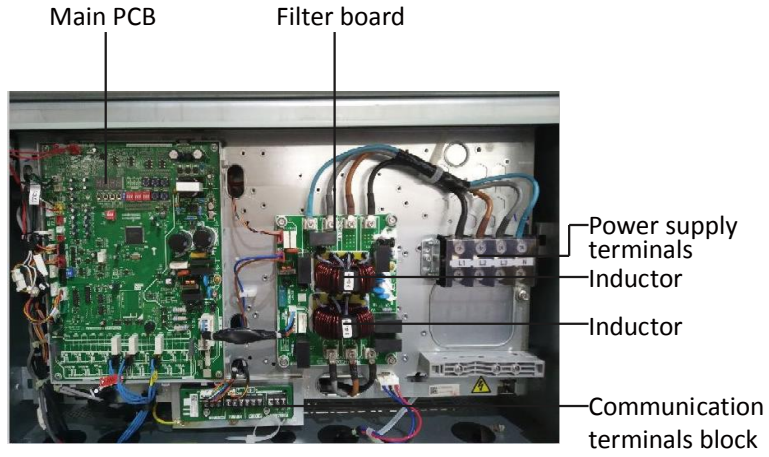
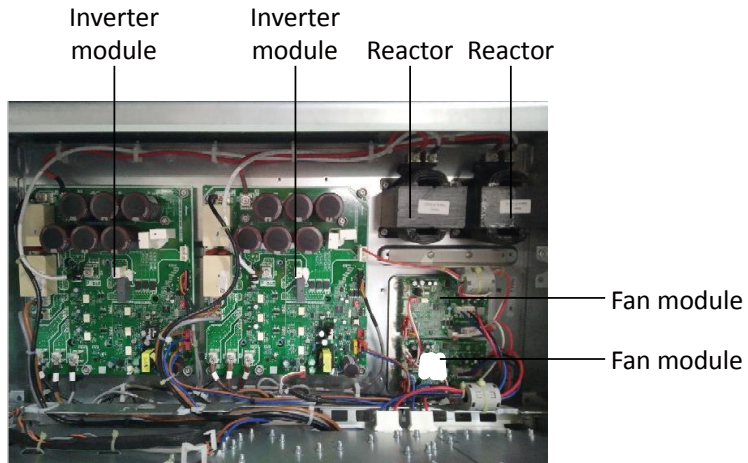

Figure 5-1.4: 18-30HP bottom layer of electric control box



2 Outdoor Unit Main PCB

2.1 Ports

Figure 5-2.1: Outdoor unit main PCB ports¹

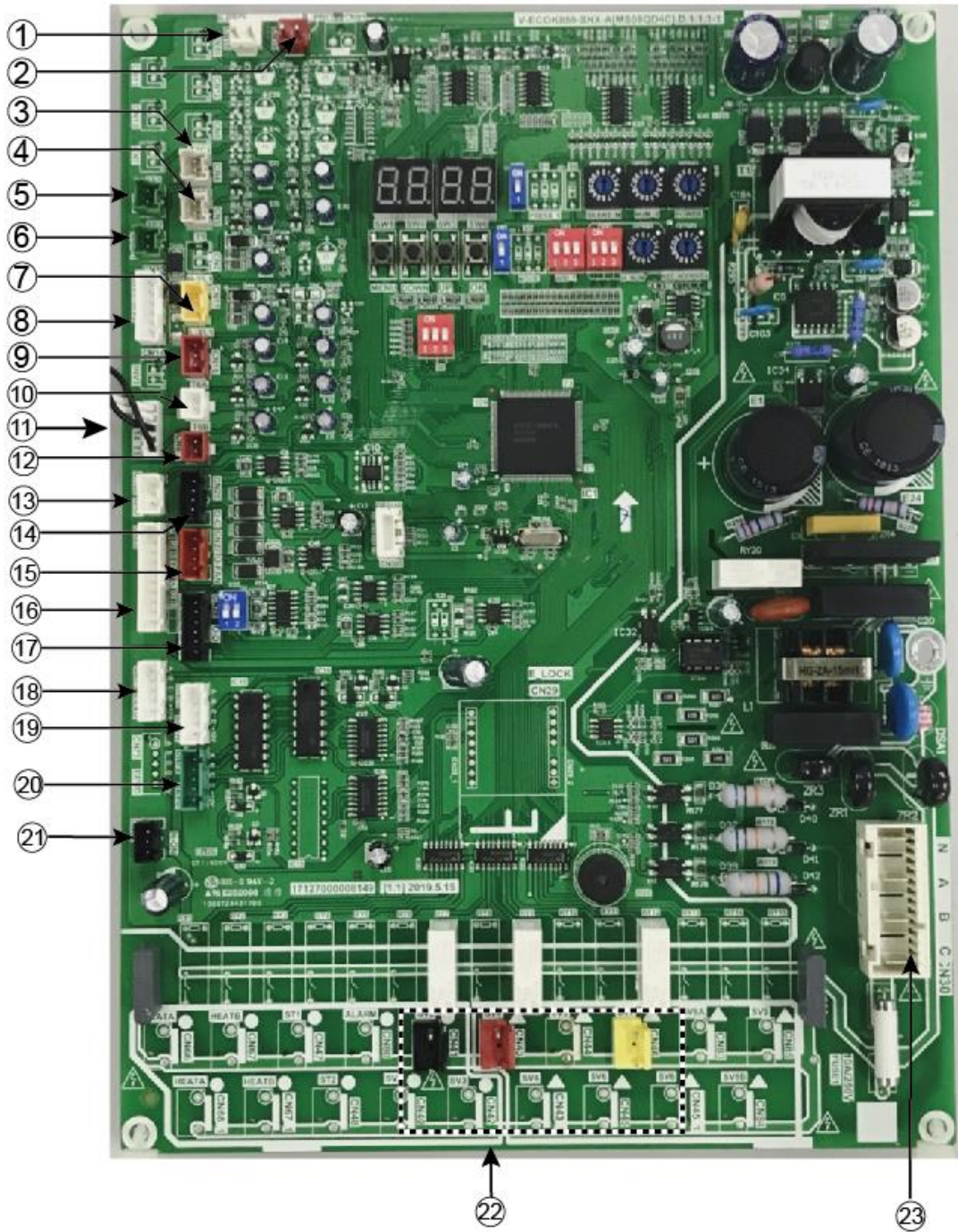

Notes:

1. Label descriptions are given in Table 5-2.1.

Table 5-2.1: Main PCB ports

Label	Port code	Content	Port voltage
1	CN18	Reserved	/
2	CN19	Low pressure switch connection	0V or 5V DC
3	CN4	Compressor top temperature sensor (single compressor units) or compressor A compressor top temperature sensor (dual compressor units) connection	0-5V DC (varying)
4	CN5	Discharge pipe temperature sensor (single compressor units) or compressor B compressor top temperature sensor (dual compressor units) connection	0-5V DC (varying)
5	CN3	Inverter module temperature sensor A connection	0-5V DC (varying)
6	CN3_1	Inverter module temperature sensor B connection	0-5V DC (varying)
7	CN17	High pressure sensor connection	0-5V DC (varying)
8	CN15	Reserved	/
9	CN16	Reserved	/
10	CN8	Reserved	/
11	CN1	Outdoor ambient temperature sensor and outdoor heat exchanger temperature sensor connections	0-5V DC (varying)
12	CN8_1	Reserved	/
13	CN20	Communication port to outdoor units	2.5-2.7V DC
14	CN26	Communication port to compressor drive board	2.5-2.7V DC
15	CN27	Communication port to fan drive board	2.5-2.7V DC
16	CN25	Communication port to communication terminal block	2.5-2.7V DC
17	CN28	Reserved	/
18	CN71	Reserved	/
19	CN70	EXVA drive port	0V or 12V DC
20	CN72	Reserved	/
21	CN82	Control port of relay for AC filter board	0V or 12V DC
22	CN41, CN43, CN46	Solenoid valve drive ports	0V or 220V AC
23	CN30	Power input of main board	220V AC between A/B/C and N; 380V AC between A,B and C

2.2 Components

2.2.1 Layout

Figure 5-2.2: Outdoor unit main PCB components

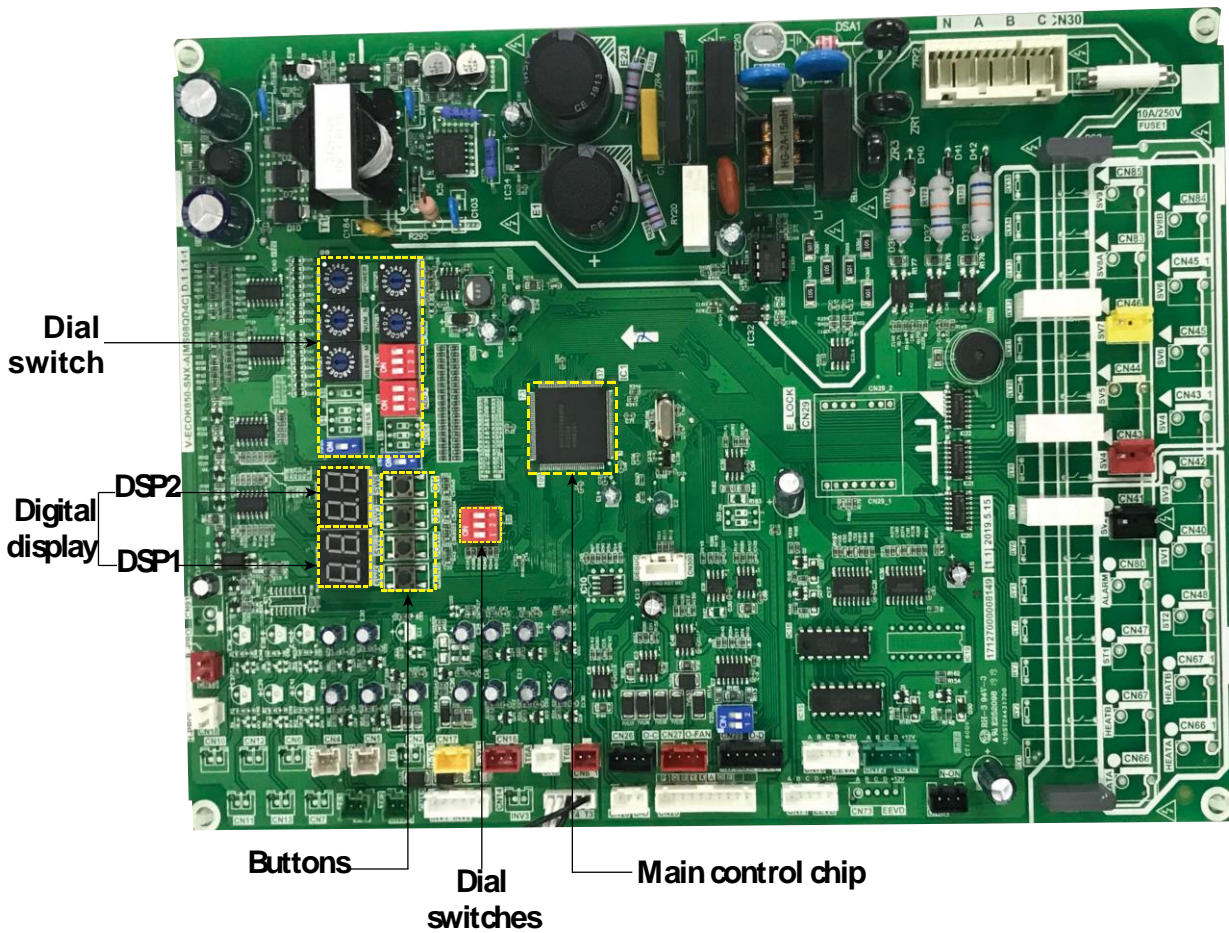

TVR Pro CO Series Service Manual

2.2.2 Function of buttons SW3 to SW6

Table 5-2.2: Function of buttons SW3 to SW6

Button	Function
SW3 (UP)	In menu mode: previous and next buttons for menu modes.
SW4 (DOWN)	Not in menu mode: previous and next buttons for system check information.
SW5 (MENU)	Enter / exit menu mode.
SW6 (OK)	Confirm to enter specified menu mode.



2.2.3 Menu mode

Only master unit has the full menu functions, slaves units only have error codes check and cleaning functions.

1. Long press SW5 "MENU" button for 5 seconds to enter menu mode, and the digital display displays "n1";
2. Press SW3 / SW4 "UP / DOWN" button to select the first level menu "n1", "n2", "n3", "n4" or "nb";
3. Press SW6 "OK" button to enter specified first level menu, for example, enter "n4" mode;
4. Press SW3 / SW4 "UP / DOWN" button to select the second level menu from "n41" to "n47";
5. Press SW6 "OK" button to enter specified second level menu, for example, enter "n43" mode;

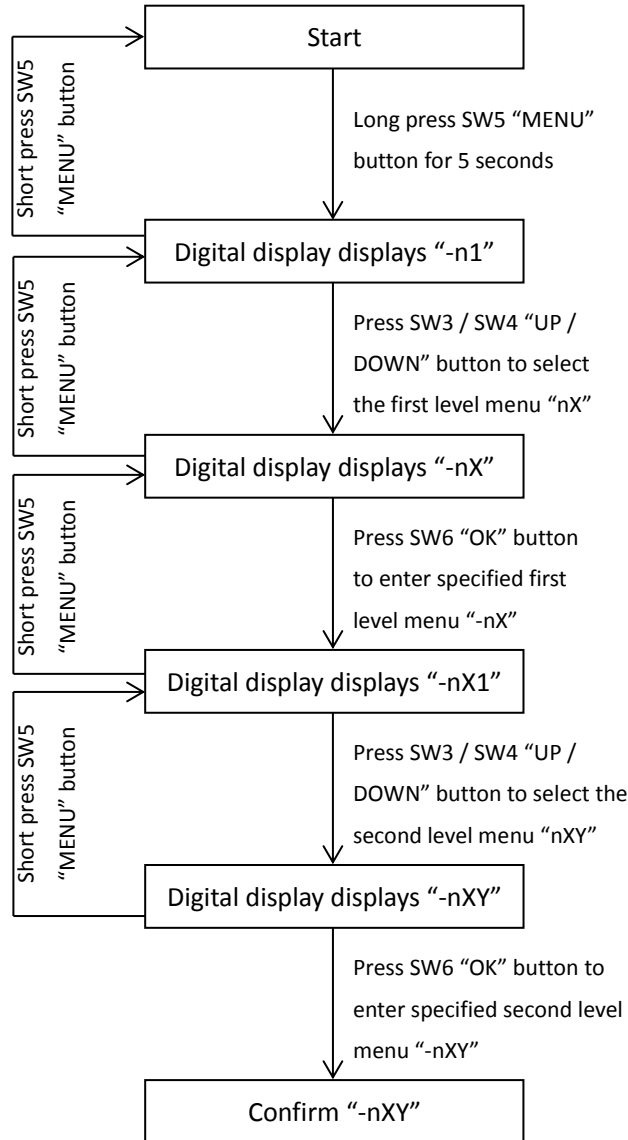
Menu mode selection flowchart:

Menu mode function:

Table 5-2.3: Menu mode function

Digital display content	Menu mode	Remarks
n14	Debug mode	Only available for the master unit (all indoor units running in cooling mode)
n16	Maintenance mode	Only available for the master unit, the system does not check the indoor units' number.
n24	Reserved	
n25	Reserved	
n26	Backup run	Only available for outdoor unit with two compressors. If one of the two compressors is fail, the other compressor will keep running for up to 4 days and then stop automatically.
n27	Vacuum mode	It is only used in maintenance process. The digital display displays "R006", all solenoid valves are open and EXVs are open to the maximum steps.
n31	History error codes	Display recent ten history error codes
n32	Cleaning history error codes	
n33	Reserved	
n34	Factory reset	Only available for the master unit
n41	Power limitation mode 1	Only available for the master unit, 100% capacity output
n42	Power limitation mode 2	Only available for the master unit, 90% capacity output
n43	Power limitation mode 3	Only available for the master unit, 80% capacity output
n44	Power limitation mode 4	Only available for the master unit, 70% capacity output
n45	Power limitation mode 5	Only available for the master unit, 60% capacity output
n46	Power limitation mode 6	Only available for the master unit, 50% capacity output
n47	Power limitation mode 7	Only available for the master unit, 40% capacity output
nb1	Fahrenheit degree setting (°F)	Only available for the master unit
nb2	Celsius degree setting (°C)	Only available for the master unit
nb3	Exit auto power save mode ¹	Only available for the master unit
nb4	Enter auto power save mode ¹	Only available for the master unit
nb5	Auto snow-blowing mode 1 (customized)	According to outdoor ambient temperature (T4), the outdoor fan(s) periodically stop for 15 minutes and run for 2 minute
nb6	Auto snow-blowing mode 2 (customized)	According to outdoor ambient temperature (T4), the outdoor fan(s) periodically stop for 30 minutes and run for 2 minute
nb7	Exit auto snow-blowing mode	
nb8	VIP address setting	The digital display will display "IdXX", "XX" stands for VIP address, use UP / DOWN button to change the VIP address and press OK button to confirm the specified VIP address.
nF1	Reserved	
nF2	Reserved	

Notes:

1. Auto power save mode means EMS mode, the evaporating temperature (in cooling) is automatically adjusted according to both indoor and outdoor temperature to maximize the comfort and energy efficiency. Exit auto power save mode, the evaporating temperature (in cooling) is fixed.

How to exit specified menu mode:
Table 5-2.4: Exit specified menu mode method:

Menu mode	Manual exit method	Automatic exit method	System restart
Debug mode	Long press SW6 "OK" button when the digital display is not in menu selection state	After running 120 minutes	Invalid
Maintenance mode	/	After running 60 minutes	Invalid
Backup run	/	After running 4 days or both two compressors are failed	Invalid
Vacuum mode	Long press SW6 "OK" button when the digital display is not in menu selection state	After running 8 hours	Invalid
Power limitation mode	Select power limitation mode 1 "n41"	/	Valid
Auto power save mode	Select "nb3"	/	Valid
Auto snow-blowing mode 1 (2)	Select "nb7"	/	Valid
VIP address setting	/	/	Valid
°F / °C setting	/	/	Valid

2.2.4 UP / DOWN system check button

Before pressing UP or DOWN button, allow the system to operate steadily for more than an hour. On pressing UP or DOWN button, the parameters listed in Table 5-2.5 will be displayed in sequence.

Table 5-2.5: System check

DSP1 content	Parameters displayed on DSP2	Remarks
0.--	Unit address	Master unit: 0; slave units: 1, 2
1.--	Unit capacity	Refer to Note 1
2.--	Number of outdoor units	Displayed on master unit PCB only
3.--	Number of indoor units as set on PCB	Displayed on master unit PCB only
4.--	Total capacity of outdoor unit	Only available for master unit, displayed on slave units has no sense
5.--	Total capacity requirement of indoor units	Displayed on master unit PCB only
6.--	Total corrected capacity requirement of master units	Displayed on master unit PCB only
7.--	Operating mode	Refer to Note 2
8.--	Outdoor unit actual operating capacity	
9.--	Fan A speed index	Refer to Note 3
10.--	Fan B speed index	Refer to Note 3
11.--	Indoor heat exchanger pipe (T2/T2B) temperature (°C)	Actual value = value displayed
12.--	Main heat exchanger pipe (T3) temperature (°C)	Actual value = value displayed
13.--	Outdoor ambient (T4) temperature (°C)	Actual value = value displayed
14.--	Inverter compressor A discharge temperature (°C)	Actual value = value displayed
15.--	Inverter compressor B discharge temperature (°C)	Actual value = value displayed
16.--	Inverter module A heatsink temperature (°C)	Actual value = value displayed
17.--	Inverter module B heatsink temperature (°C)	Actual value = value displayed
18.--	Discharge superheat degree (°C)	Actual value = value displayed
19.--	Reserved	
20.--	Reserved	
21.--	EXVA position	Refer to Note 4
22.--	Compressor discharge pressure (MPa)	Actual value = value displayed × 0.1
23.--	Reserved	
24.--	Number of indoor units currently in communication with master unit	Actual value = value displayed
25.--	Number of indoor units currently operating	Displayed on master unit PCB only
26.--	Reserved	
27.--	Silent mode	Refer to Note 5
28.--	Static pressure mode	Refer to Note 6
29.--	Reserved	
30.--	Reserved	
31.--	DC voltage A	Actual value = value displayed × 10
32.--	DC voltage B	Actual value = value displayed × 10
33.--	Reserved	

Table continued on next page ...

Table 5-2.5: System check (continued)

DSP1 content	Parameters displayed on DSP2	Remarks
34.--	Address of VIP indoor unit	
35.--	Reserved	
36.--	Reserved	
37.--	Refrigerant quantity	Refer to Note 7
38.--	Reserved	
39.--	Power mode	Refer to Note 8
40.--	Most recent error or protection code	"--" is displayed if no error or protection events have occurred since start-up
--	--	End

- Notes:
- Outdoor unit capacity setting:
 - 0: 8HP; 1: 10HP; 2: 12HP; 3: 14HP; 4: 16HP; 5: 18HP; 6: 20HP; 7: 22HP; 8: 24HP; 9: 26HP; A: 28HP; B: 30HP; C: 30HP.
 - Operating mode:
 - 0: off; 2: cooling; 3: null; 4: forced cooling.
 - The fan speed index is related to the fan speed in rpm and can take any integer value in the range 1 (slowest) to 37 (fastest).
 - 480P: steps = value displayed × 4; 3000P: steps = value displayed × 24.
 - Silent mode:
 - 0: night silent time 6h/10h; 1: night silent time 6h/12h; 2: night silent time 8h/10h; 3: night silent time 8h/12h; 4: no silent mode; 5: silent mode 1; 6: silent mode 2; 7: silent mode 3; 8: super silent mode 1; 9: super silent mode 2; 10: super silent mode 3; 11: super silent mode 4.
 - Static pressure mode:
 - 0: standard static pressure; 1: low static pressure; 2: medium static pressure; 3: high static pressure; 4: super high static pressure.
 - Refrigerant quantity:
 - 0: normal; 1: slightly excessive; 2: significantly excessive; 3: slightly insufficient; 4: significantly insufficient; 5: critically insufficient.
 - Power mode:
 - 0: 100% capacity output; 1: 90% capacity output; 2: 80% capacity output; 3: 70% capacity output; 4: 60% capacity output; 5: 50% capacity output; 6: 40% capacity output; 10: auto power save mode, 100% capacity output; 11: auto power save mode, 90% capacity output; 12: auto power save mode, 80% capacity output; 13: auto power save mode, 70% capacity output; 14: auto power save mode, 60% capacity output; 15: auto power save mode, 50% capacity output; 16: auto power save mode, 40% capacity output;

2.2.5 Digital display output

Table 5-2.6: Digital display output in different operating states

Outdoor unit state		Parameters displayed on DSP1	Parameters displayed on DSP2
Standby		Unit's address	The number of indoor units in communication with the outdoor units
Normal operation	For single compressor units	--	Running speed of the compressor in rotations per second
	For dual compressor units	Running speed of compressor A in rotations per second	Running speed of compressor B in rotations per second
Error or protection		-- or placeholder	Error or protection code
In menu mode		Refer to Table 5-2.3	Refer to Table 5-2.3
System check		Refer to Table 5-2.5	Refer to Table 5-2.5

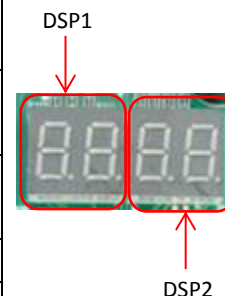

3 Compressor Inverter Module

3.1 Ports

Figure 5-3.1: Compressor inverter module ports

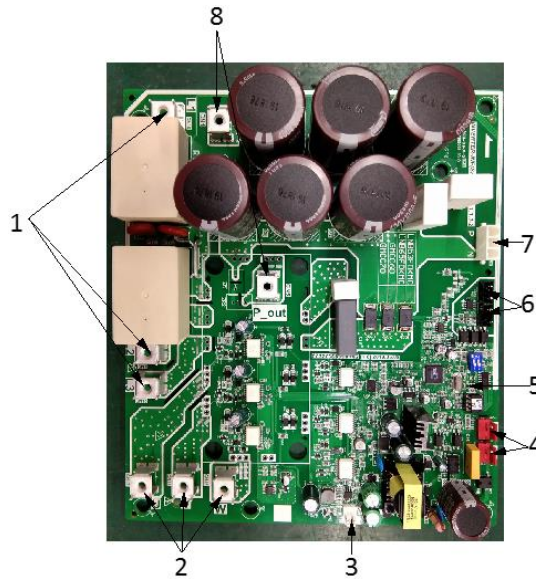
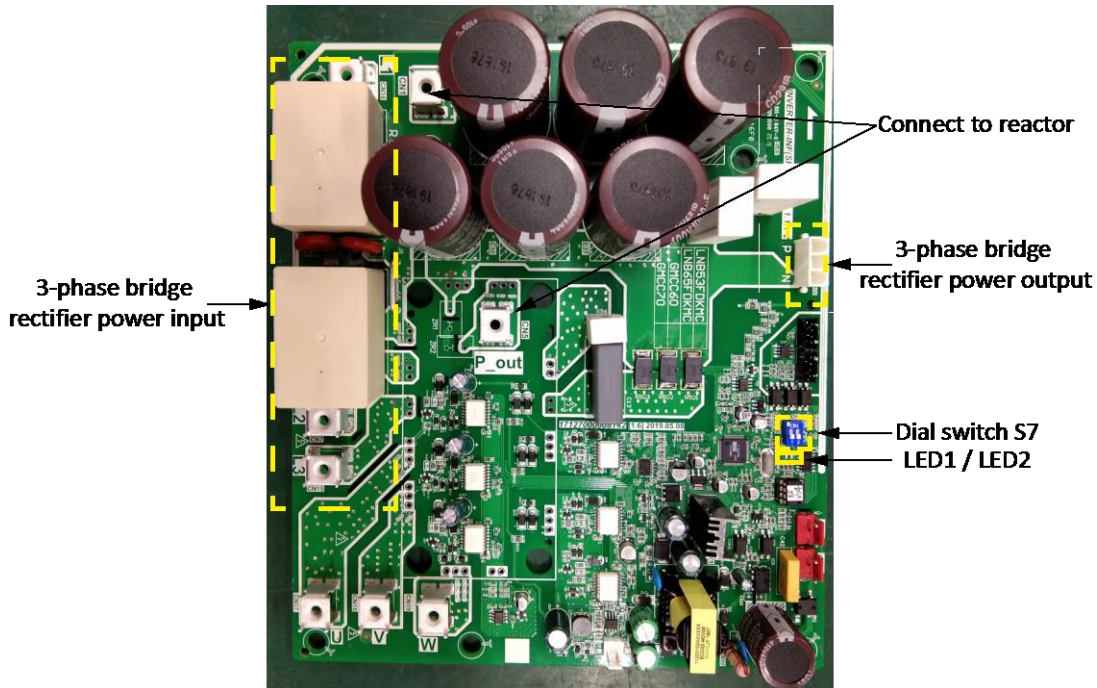

Table 5-3.1: Compressor inverter module PCB ports

Label	Port code	Content	Port voltage
1	CN7\CN15\CN16	3-phase power supply port to inverter module	380V AC
2	CN17\CN18\CN19	Inverter module power output port to compressor U V W	/
3	CN20	Fan module power output port	18-22V DC
4	CN4\CN6	Inverter module control port	220V AC
5	LED1\LED2	Inverter module operating indicator LED1 Inverter module error indicator LED2	0-3.3V DC (varying)
6	CN8\CN9	Communication port to main board	0-5V DC (varying)
7	CN38	Power supply port to fan module IPM	485-645V DC
8	CN1\CN5	Connect to reactor	/

3.2 Layout

Figure 5-3.2: Compressor inverter module components



3.2.1 LED indicators LED1 and LED2

Table 5-3.2: LED indicators LED1 and LED2

Indicator	LED indicator function and status	
LED 1	Inverter module operating indicator. Continuously on if the compressor is running normally and flashing if an inverter module error has occurred ¹ .	
LED 2	Inverter module error indicator. Continuously on if an inverter module error has occurred ¹ .	

Note:

1. If an inverter module error occurs, refer to Part 6, "Xh4 Troubleshooting". The error code is displayed on the digital display.

3.2.2 Dial switch S7 setting

Dial switch S7 is used to set compressor inverter module A/B address. The compressor inverter module A/B location refers to the wiring diagram.

S7 on inverter module	Inverter module address
	0 for compressor inverter module A
	1 for compressor inverter module B

4 Fan Module

4.1 Ports

Figure 5-4.1: Compressor inverter module ports

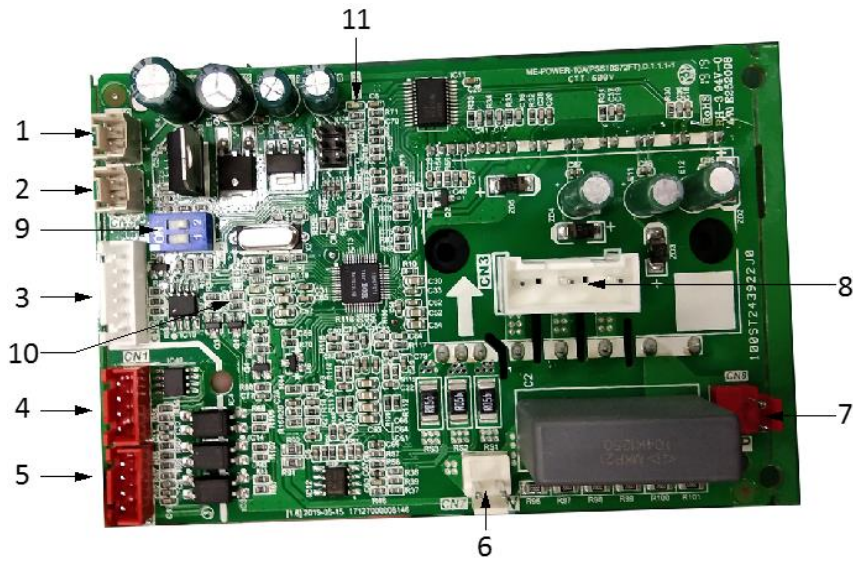

Table 5-4.1: Fan module PCB ports

Label in	Port code	Content	Port voltage
1	CN6	Power supply port to fan module control part	18-22V DC
2	CN5	Power supply port to fan module control part	18-22V DC
3	CN2	Program upgrade port	/
4	CN1	Communication port to main board	0-5V DC (varying)
5	CN4	Communication port to main board	0-5V DC (varying)
6	CN7	Power supply port "N" to fan module IPM	Voltage between P and N is 485-645V
7	CN8	Power supply port "P" to fan module IPM	Voltage between P and N is 485-645V
8	CN3	Connect to fan motor	/
9	SW1	Fan module address dial switch ¹	Note 1
10	LED2	Fan module error indicator	/
11	LED1	Fan module operating indicator	/

Notes:

- This dial switch is used to set fan module A/B address. The fan module A/B location refers to the wiring diagram.

Dial switch on fan module	Fan module address
	0 for fan module A
	1 for fan module B

TVR Pro CO 50/60Hz



5 Wiring Diagrams

8-16HP

Figure 5-5.1: 8-16HP wiring diagram

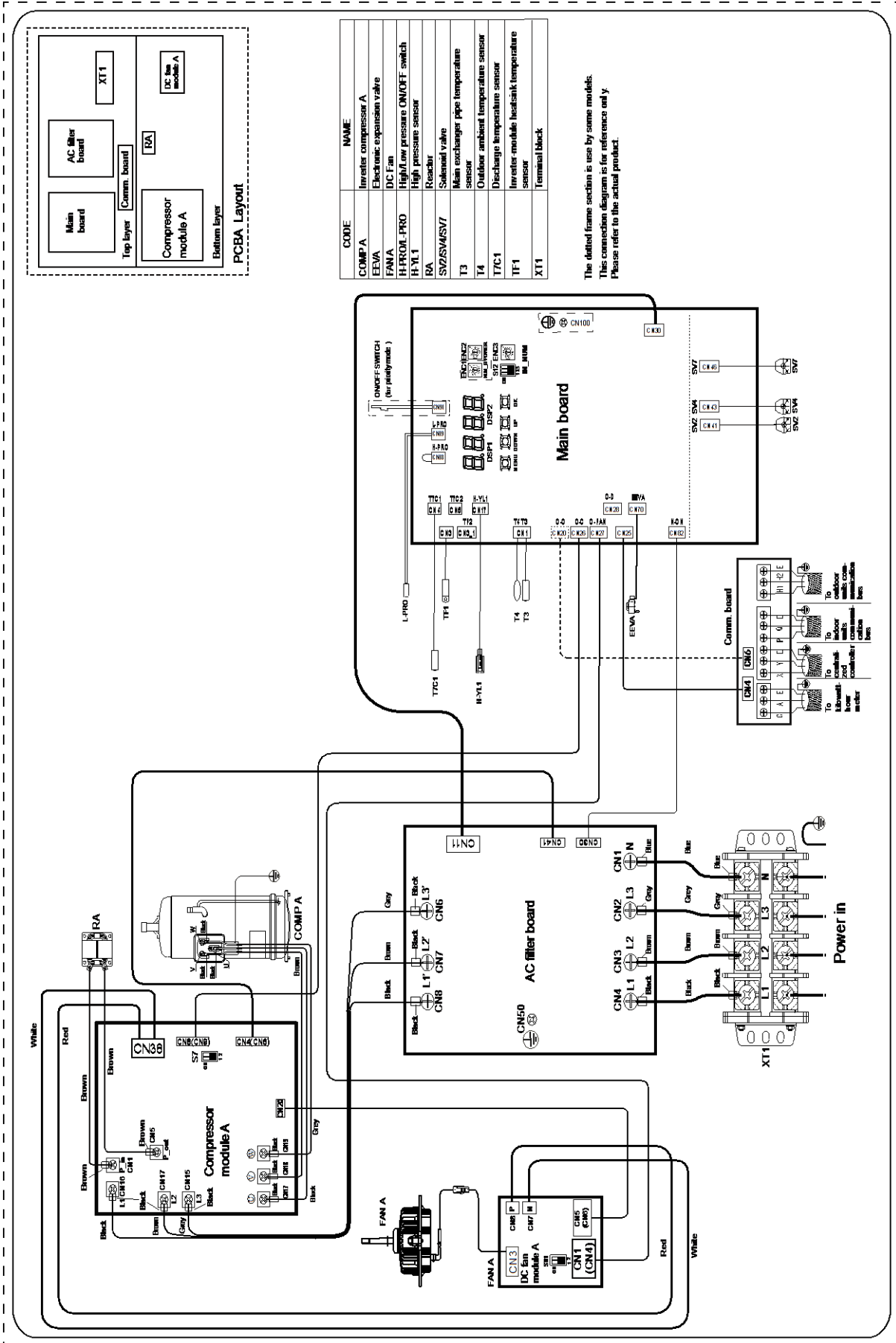

18-30HP

Figure 5-5.2: 18-30HP wiring diagram

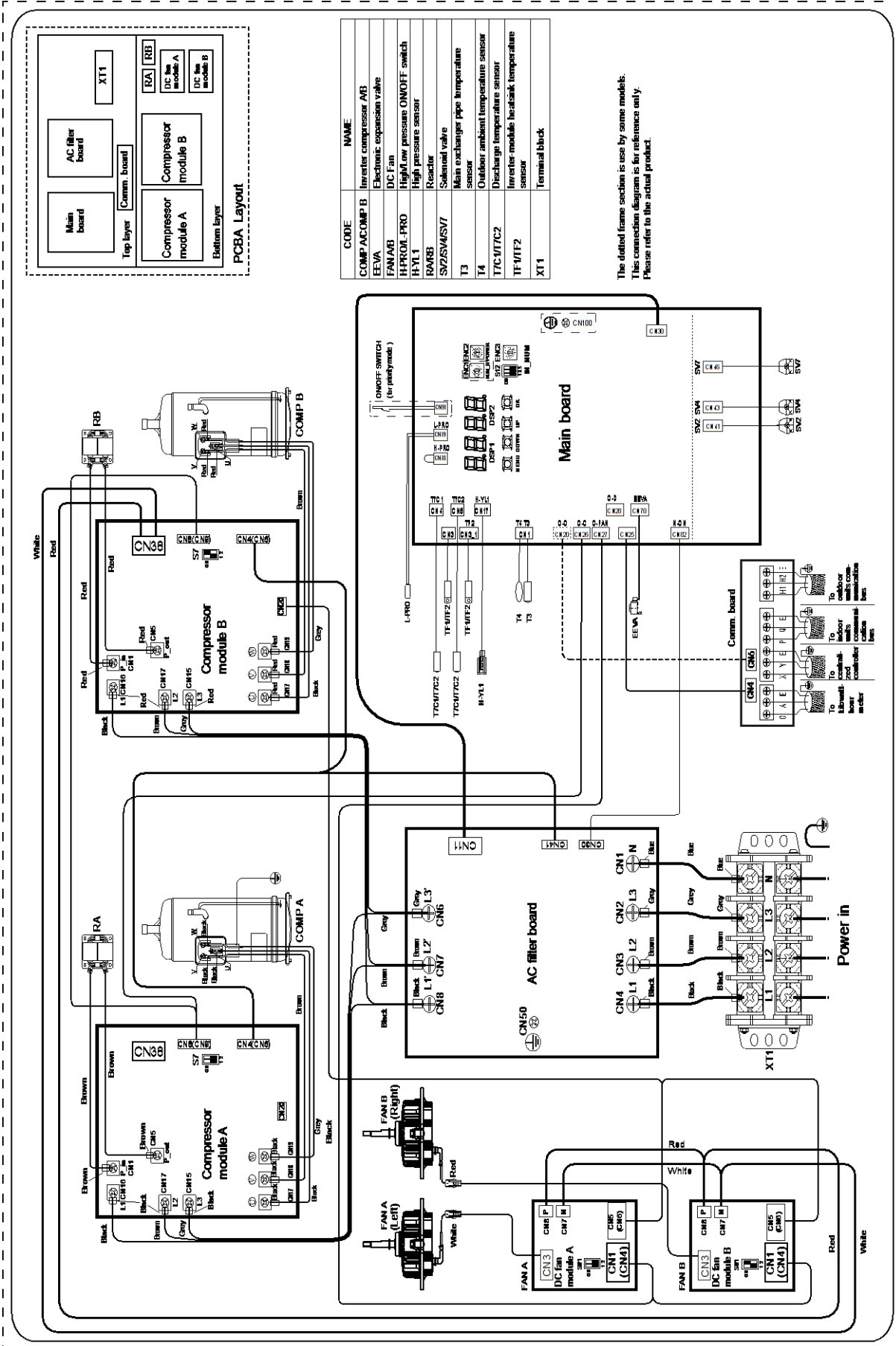

Part 6

Diagnosis and Troubleshooting

1	Error Code Table	56
2	Troubleshooting	57
3	Appendix to Part 6	110

1 Error Code Table

Table 6-1.1: Error code table

Error code ¹	Content	Remarks	Manual re-start required ²
E0	Communication error between outdoor units	Only displayed on the slave unit with the error	No
E1	Phase sequence error	Displayed on the unit with the error	Yes
E2	Communication error between indoor and master unit	Only displayed on the master unit	No
E4	Outdoor heat exchanger temperature sensor (T3) error or outdoor ambient temperature sensor (T4) error	Displayed on the unit with the error	No
E5	Abnormal power supply voltage	Displayed on the unit with the error	No
E7	Compressor top or discharge pipe temperature sensor (T7C1/T7C2) error	Displayed on the unit with the error	Yes
E8	Outdoor unit address error	Displayed on the unit with the error	Yes
xE9	EEPROM mismatch	Displayed on the unit with the error	Yes
xF1	DC bus voltage error	Displayed on the unit with the error	No
XF6	Electronic expansion valve connection error	Displayed on the unit with the error Refer to Note 3	Yes
xH0	Communication error between main control chip and inverter driver chip	Displayed on the unit with the error	No
H2	Number of slave units detected by master unit has decreased	Only displayed on the master unit	No
H3	Number of slave units detected by master unit has increased	Only displayed on the master unit	No
xH4	Inverter module protection	Displayed on the unit with the error	Yes
H5	P2 protection appears three times in 60 minutes	Displayed on the unit with the error	Yes
H6	P4 protection appears three times in 100 minutes	Displayed on the unit with the error	Yes
H7	Number of indoor units detected by master unit not same as number set on main PCB	Only displayed on the master unit	No
H8	High pressure sensor error	Displayed on the unit with the error	No
xH9	P9 protection appears ten times in 120 minutes	Displayed on the unit with the error	Yes
yHd	Slave unit malfunction	Only displayed on the master unit	No
C7	PL protection appears three times in 100 minutes	Displayed on the unit with the error	Yes
P1	Discharge pipe high pressure protection	Displayed on the unit with the error	No
P2	Suction pipe low pressure protection	Displayed on the unit with the error	No
P4	Discharge temperature protection	Displayed on the unit with the error	No
P5	Outdoor heat exchanger temperature protection	Displayed on the unit with the error	No
xP9	Fan module protection	Displayed on the unit with the error	No

Table continued on next page ...

Table 6-1.1: Error code table (continued)

Error code ¹	Content	Remarks	Manual re-start required ²
PL	Inverter module temperature protection	Displayed on the unit with the error	No
PP	Compressor discharge insufficient superheat protection	Displayed on the unit with the error	No
xL0	Inverter module protection	Displayed on the unit with the error	Yes
xL1	DC bus low voltage protection	Displayed on the unit with the error	Yes
xL2	DC bus high voltage protection	Displayed on the unit with the error	Yes
xL4	MCE error	Displayed on the unit with the error	Yes
xL5	Zero speed protection	Displayed on the unit with the error	Yes
xL7	Phase sequence error	Displayed on the unit with the error	Yes
xL8	Compressor frequency variation greater than 15Hz within one second protection	Displayed on the unit with the error	Yes
xL9	Actual compressor frequency differs from target frequency by more than 15Hz protection	Displayed on the unit with the error	Yes

Notes:

- 'x' is a placeholder for the compressor system (compressor and related electrical components), with 1 representing compressor system A and 2 representing compressor system B. 'y' is a placeholder for the address (1 or 2) of the slave unit with the error.
- For some error codes, a manual restart is required before the system can resume operation.
- Once the EXV has been connected properly, the error code will flash to indicate that the connection has been re-established. A manual restart is then required before the system can resume operation.

2 Troubleshooting

2.1 Warning

Warning



- All electrical work must be carried out by competent and suitably qualified, certified and accredited professionals and in accordance with all applicable legislation (all national, local and other laws, standards, codes, rules, regulations and other legislation that apply in a given situation).
- Power-off the outdoor units before connecting or disconnecting any connections or wiring, otherwise electric shock (which can cause physical injury or death) may occur or damage to components may occur.

2.2 E0: Communication error between outdoor units

2.2.1 Digital display output

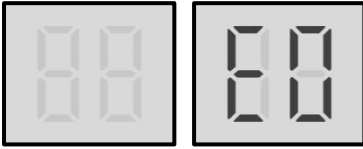

2.2.2 Description

- Communication error between outdoor units.
- All units stop running.
- Error code is only displayed on the slave unit with the error.

2.2.3 Trigger / recover condition

- Trigger condition: Slave unit cannot receive signal from master unit for 60s.
- Recover condition: Slave unit can receive signal from master unit.
- Reset method: Resume automatically.

2.2.4 Possible causes

- Incorrect outdoor unit address setting.
- Communication wires between outdoor units not connected properly.
- Loosened wiring within electric control box.
- Damaged main PCB or electric control box communication terminals block.

2.2.5 Procedure

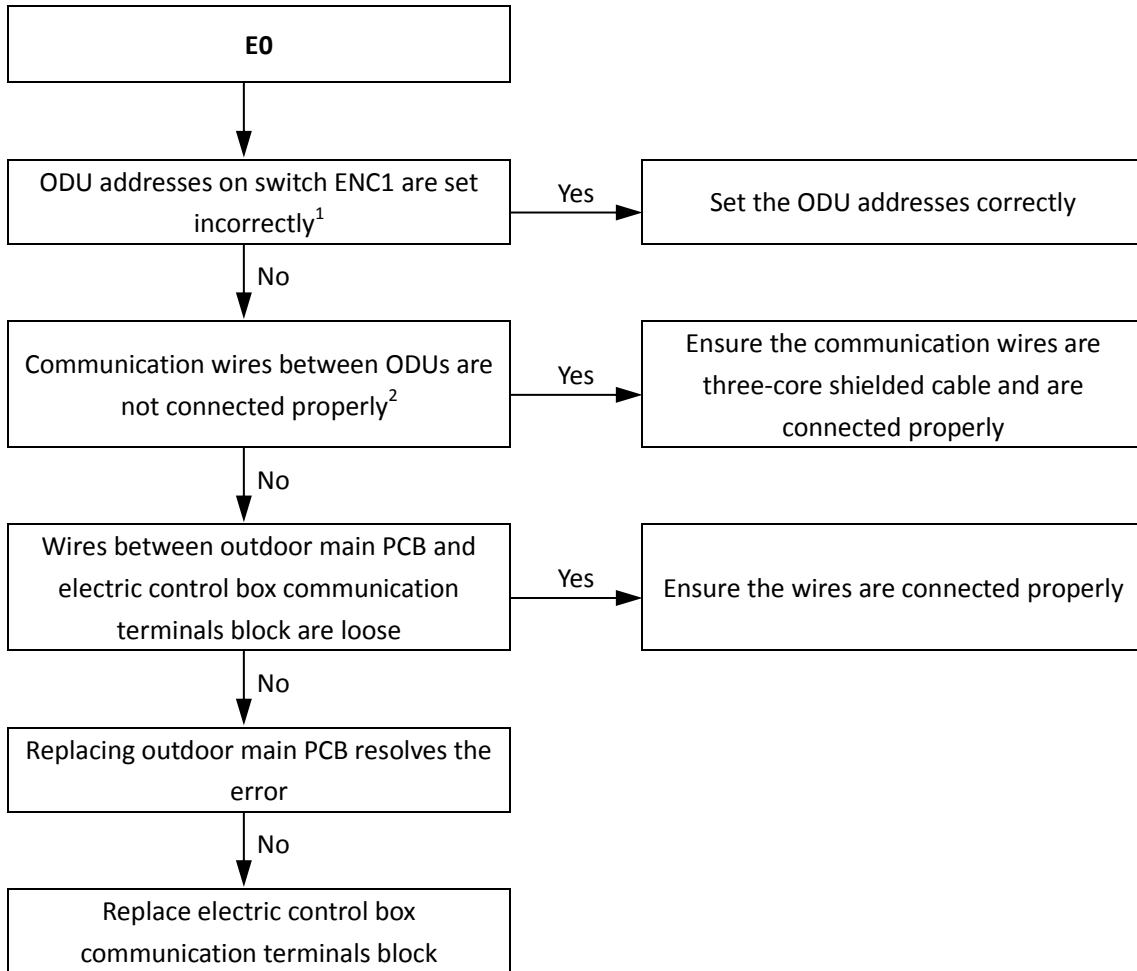

Notes:

1. The master unit address should be set as 0, slave units addresses should be set from 1 to 2, and the addresses should not be repeated within one system.
2. All the wires for H1, H2, E connections should be three-core shielded cable, the wiring should be connected according to polarity (H1 to H1, etc), the wiring should not be open or short circuited.

2.3 E1: Phase sequence error

2.3.1 Digital display output

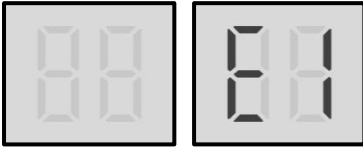

2.3.2 Description

- Phase sequence error.
- All units stop running.
- Error code is only displayed on the unit with the error.

2.3.3 Trigger / recover condition

- Trigger condition: Wrong phase connection for 1.6s or phase missing for 48s.
- Recover condition: Correct phase connection.
- Reset method: Manually restart.

2.3.4 Possible causes

- Power supply phases not connected in correct sequence.
- Power supply terminals loose.
- Power supply abnormal.
- Main PCB damaged.

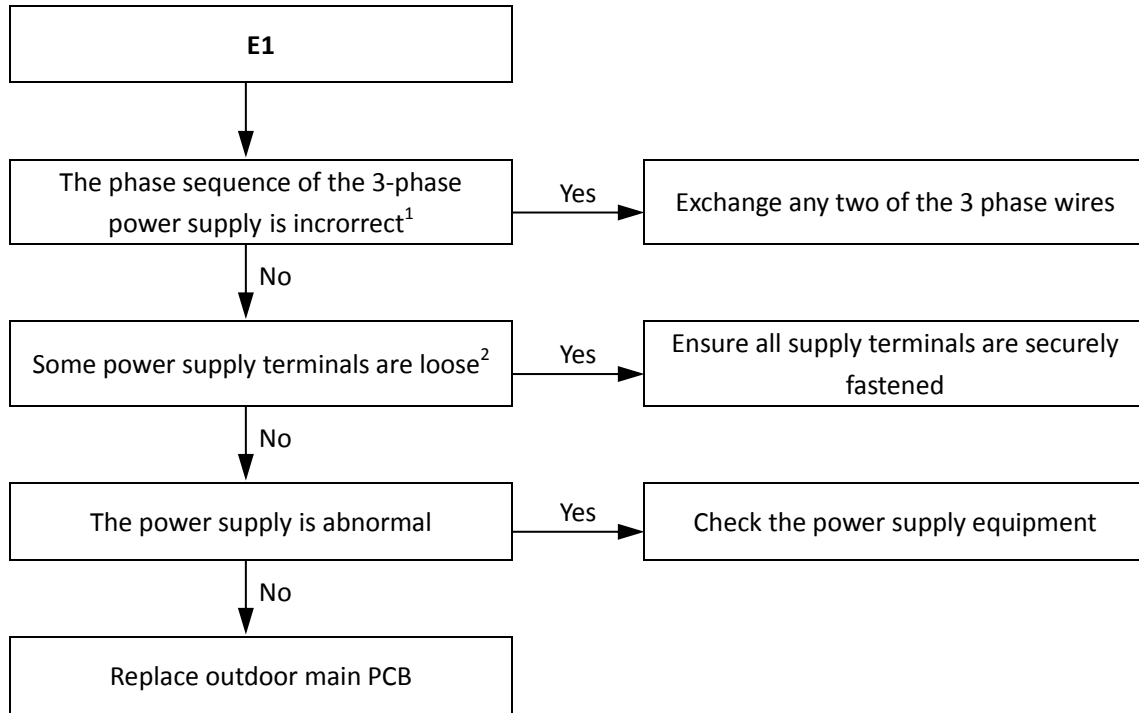
2.3.5 Procedure

Notes:

1. The A, B, C terminals of the 3-phase power supply should match compressor phase sequence requirements. If the phase sequence is inverted, the compressor will operate inversely. If the wiring connection of each outdoor unit is in A, B, C phase sequence, and multiple units are connected, the current difference between C phase and A, B phases will be very large as the power supply load of each outdoor unit will be on C phase. This can easily lead to tripped circuits and terminal wiring burnout. Therefore if multiple units are to be used, the phase sequence should be staggered, so that the current is distributed among the three phases equally.
2. Loose power supply terminals can cause the compressors to operate abnormally and compressor current to be very large.

2.4 E2: Communication error between indoor and master unit

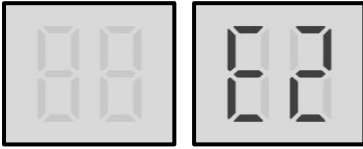
2.4.1 Digital display output



2.4.2 Description

- Communication error between indoor and master unit.
- All units stop running.
- Error code is only displayed on the master unit.

2.4.3 Trigger / recover condition

- Trigger condition: Indoor units and outdoor units cannot communication for 2 minutes after the system power on 20 minutes.
- Recover condition: Communication go back to normal.
- Reset method: Resume automatically.

2.4.4 Possible causes

- Communication wires between indoor and outdoor units not connected properly.
- Indoor unit power supply abnormal.
- Loosened wiring within electric control box.
- Interference from high voltage wires or other sources of electromagnetic radiation.
- Communication wire too long.
- Damaged main PCB or electric control box communication terminals block.

2.4.5 Procedure

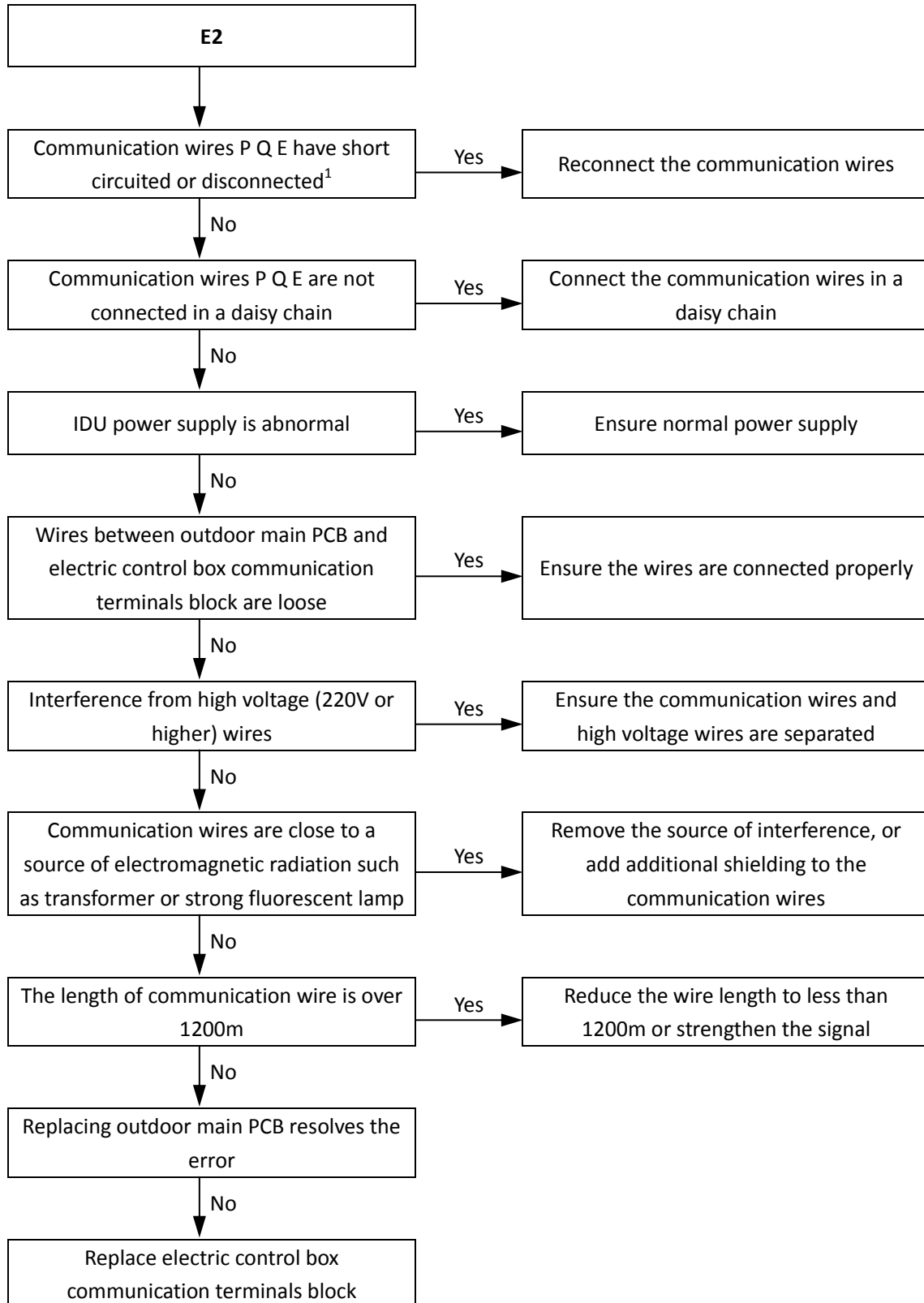

Notes:

1. Measure the resistance among P, Q and E. The normal resistance between P and Q is 120Ω, between P and E is infinite, between Q and E is infinite.

2.5 E4: Temperature sensor (T3/T4) error

2.5.1 Digital display output

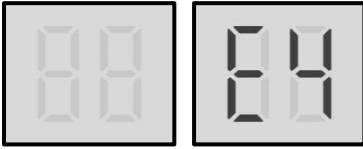

2.5.2 Description

- Outdoor heat exchanger temperature sensor (T3) error or outdoor ambient temperature sensor (T4) error.
- All units stop running.
- Error code is only displayed on the unit with the error.

2.5.3 Trigger / recover condition

- Trigger condition: The main control board cannot receive the feedback signal of temperature sensor T3 or T4.
- Recover condition: The main control board can receive the feedback signal of temperature sensor T3 or T4.
- Reset method: Resume automatically.

2.5.4 Possible causes

- Temperature sensor not connected properly or has malfunctioned.
- Damaged main PCB.

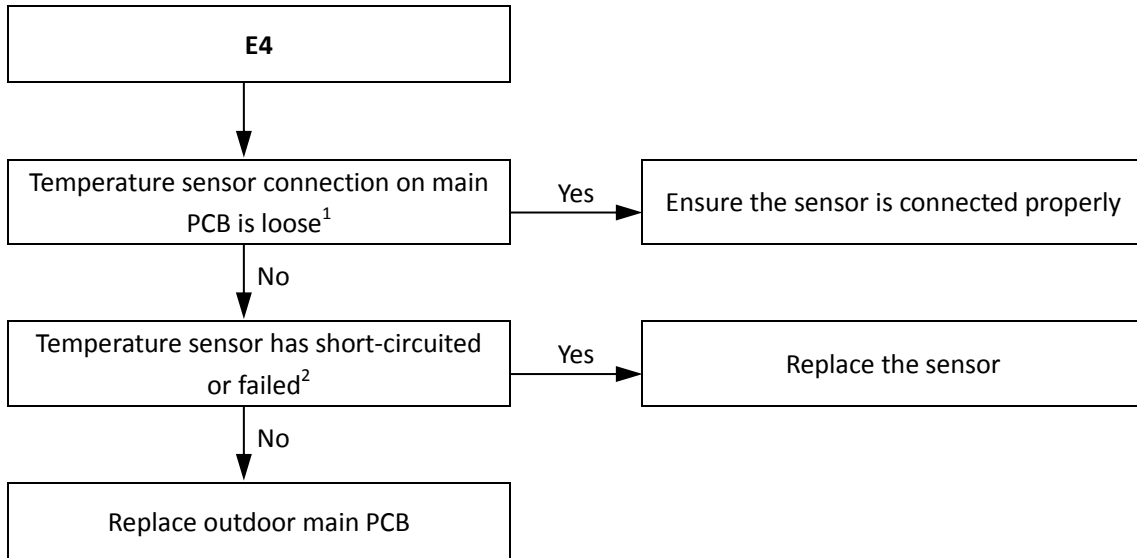
2.5.5 Procedure

Notes:

1. Outdoor ambient temperature sensor (T4) and heat exchanger temperature sensor (T3) connection is port CN1 on the main PCB (labeled 11 in Figure 5-2.1 in Part 5, 2.1 "Ports").
2. Measure sensor resistance. If the resistance is too low, the sensor has short-circuited. If the resistance is not consistent with the sensor's resistance characteristics table, the sensor has failed. Refer to Table 6-3.1 in Part 6, 3.1 "Temperature Sensor Resistance Characteristics".

2.6 E5: Abnormal power supply voltage

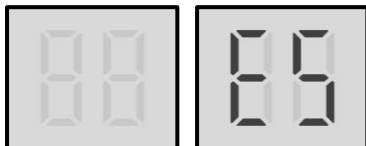
2.6.1 Digital display output



2.6.2 Description

- Abnormal power supply voltage.
- All units stop running.
- Error code is only displayed on the unit with the error.

2.6.3 Trigger / recover condition

- Trigger condition: Outdoor unit power supply phase voltage < 165V.
- Recover condition: Outdoor unit power supply phase voltage is > 180V.
- Reset method: Resume automatically.

2.6.4 Possible causes

- Outdoor unit power supply voltage is abnormal or a phase is missing.
- Loosened wiring within electric control box.
- High voltage circuit error.
- Main PCB damaged.

2.6.5 Procedure

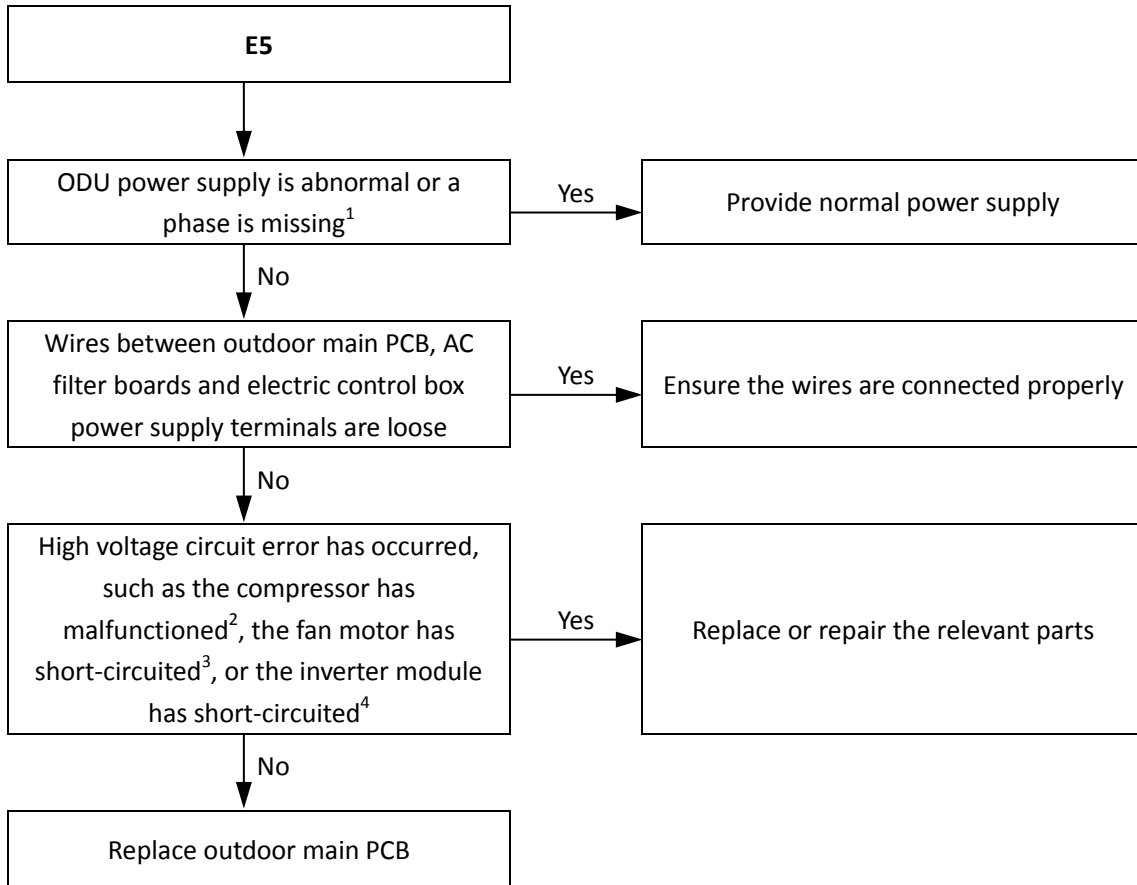

Notes:

1. The normal voltage between A and N, B and N, and C and N is 198-242V.
2. The normal resistances of the inverter compressor are 0.7-1.5Ω among U V W and infinite between each of U V W and ground. If any of the resistances differ from these specifications, the compressor has malfunctioned.
3. The normal resistances of the fan motor coil among U V W are less than 10Ω. If a measured resistance is 0Ω, the fan motor has short-circuited.
4. Set a multi-meter to buzzer mode and test any two terminals of P N U V W of the inverter module. If the buzzer sounds, the inverter module has short-circuited.

Figure: Inverter module terminals

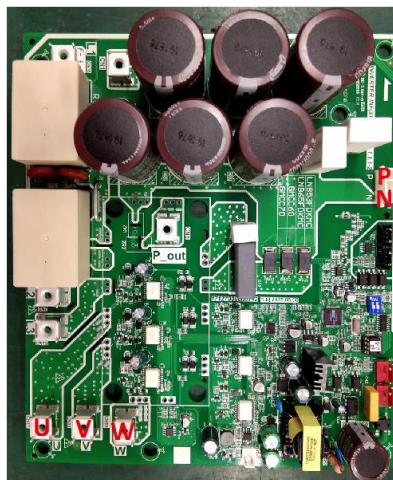

2.7 E7: Temperature sensor (T7C1/2) error

2.7.1 Digital display output

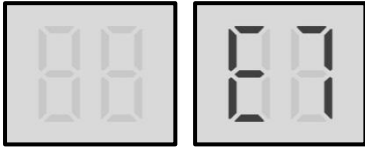

2.7.2 Description

- A compressor top temperature sensor or discharge pipe temperature sensor (T7C1/2) error.
- All units stop running.
- Error code is only displayed on the unit with the error.

2.7.3 Trigger / recover condition

- Trigger condition: Discharge pressure \geq 3MPa and discharge temperature $<$ 15°C for 2 minutes.
- Recover condition: Discharge pressure and temperature go back to normal.
- Reset method: Manually restart.

2.7.4 Possible causes

- Temperature sensor not connected properly or has malfunctioned.
- Damaged main PCB.

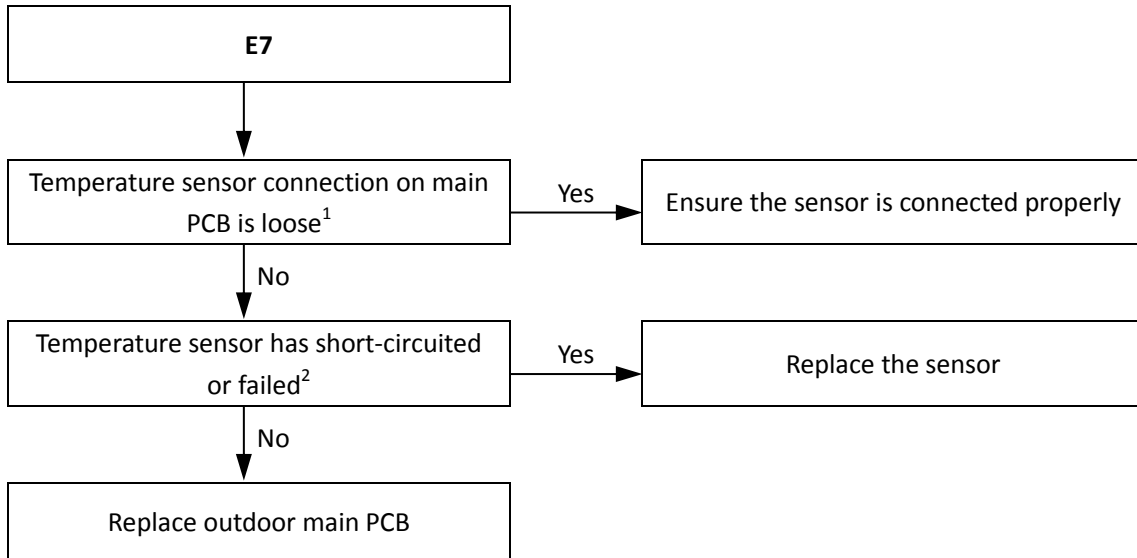
2.7.5 Procedure

Notes:

1. Compressor top temperature sensor and discharge pipe temperature sensor connections are ports CN4 and CN5 on the main PCB (labeled 3 and 4, respectively, in Figure 5-2.1 in Part 5, 2.1 "Ports").
2. Measure sensor resistance. If the resistance is too low, the sensor has short-circuited. If the resistance is not consistent with the sensor's resistance characteristics table, the sensor has failed. Refer to Table 6-3.2 in Part 6, 3.1 "Temperature Sensor Resistance Characteristics".

2.8 E8: Outdoor unit address error

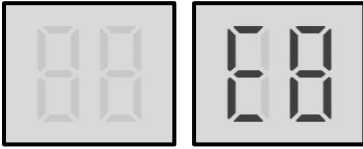
2.8.1 Digital display output



2.8.2 Description

- Outdoor unit address error.
- All units stop running.
- Error code is only displayed on the unit with the error.

2.8.3 Trigger / recover condition

- Trigger condition: Outdoor unit address is set more than 2.
- Recover condition: Outdoor unit addresses are set from 0 to 2.
- Reset method: Manually restart.

2.8.4 Possible causes

- Invalid outdoor unit address.
- Main PCB damaged.

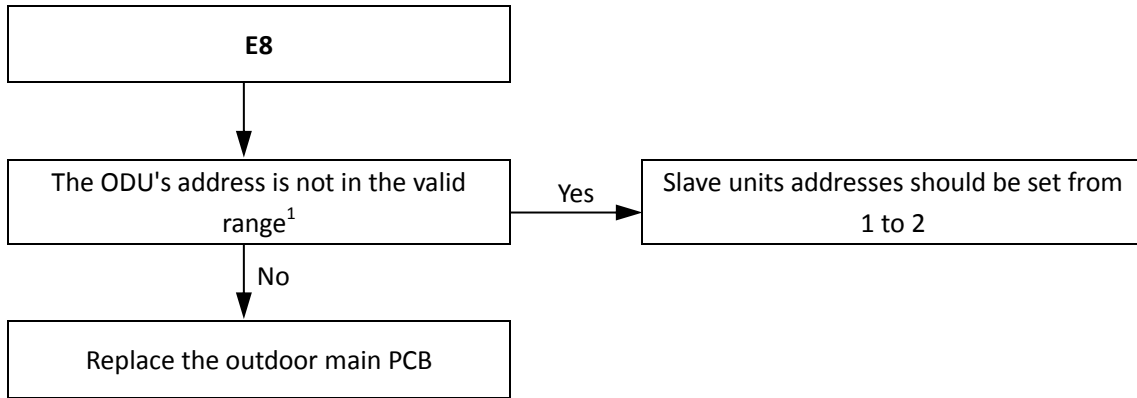
2.8.5 Procedure**Notes:**

1. The master unit address should be set as 0, slave units addresses should be set from 1 to 2, and the addresses should not be repeated within one system.

2.9 xE9: EEPROM mismatch

2.9.1 Digital display output

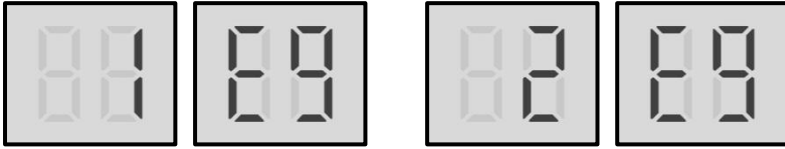

In the error code, 'x' is a placeholder for the compressor system (compressor and related electrical components), with 1 representing compressor system A and 2 representing compressor system B.

2.9.2 Description

- 1E9 indicates a compressor A EEPROM mismatch.
- 2E9 indicates a compressor B EEPROM mismatch.
- All units stop running.
- Error code is only displayed on the unit with the error.

2.9.3 Trigger / recover condition

- Trigger condition: Compressor drive parameter is mismatch.
- Recover condition: Compressor drive parameter is match.
- Reset method: Manually restart.

2.9.4 Possible causes

- Outdoor unit was powered on immediately after being powered off.
- Main PCB damaged.

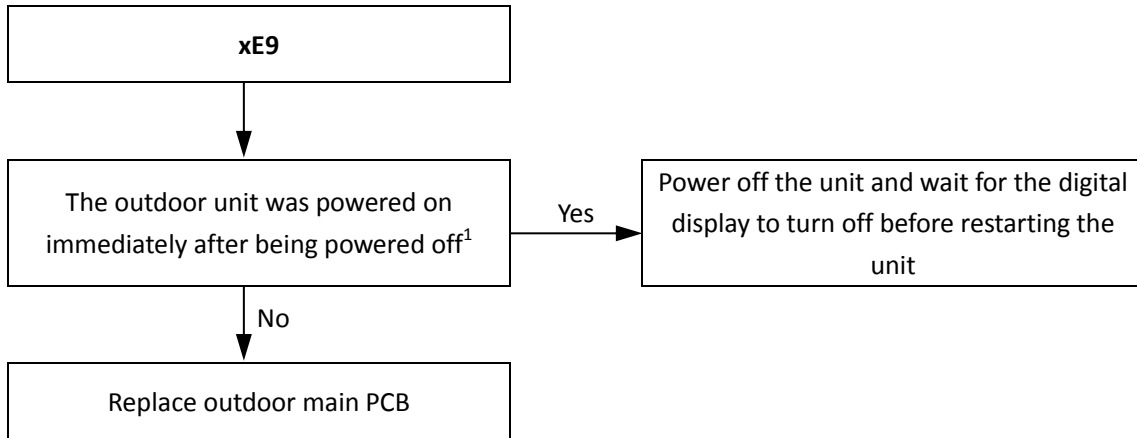
2.9.5 Procedure**Notes:**

1. When performing a manual restart of an outdoor unit, once the unit has been powered off it should not be powered on again until the digital display has turned off.

2.10 xF1: DC bus voltage error

2.10.1 Digital display output

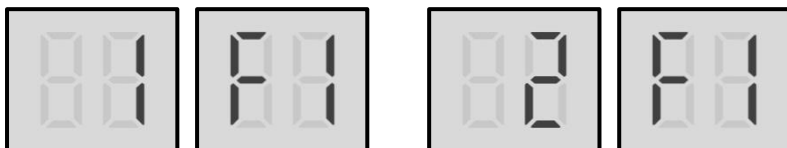

'x' is a placeholder for the compressor system (compressor and related electrical components), with 1 representing compressor system A and 2 representing compressor system B.

2.10.2 Description

- 1F1 indicates compressor A DC bus voltage error; 2F1 indicates compressor B DC bus voltage error.
- All units stop running.
- Error code is only displayed on the unit with the error.

2.10.3 Trigger / recover condition

- Trigger condition: DC bus voltage < 350V or DC bus voltage > 700V continuously for 10 seconds.
- Recover condition: DC bus voltage goes back to normal.
- Reset method: Restart automatically.

2.10.4 Possible causes

- Loosened wiring of the compressor inverter module.
- Incorrect wiring of the reactor and DC bus wire.
- Abnormal power supply.
- Inverter module damaged.

2.10.5 Procedure

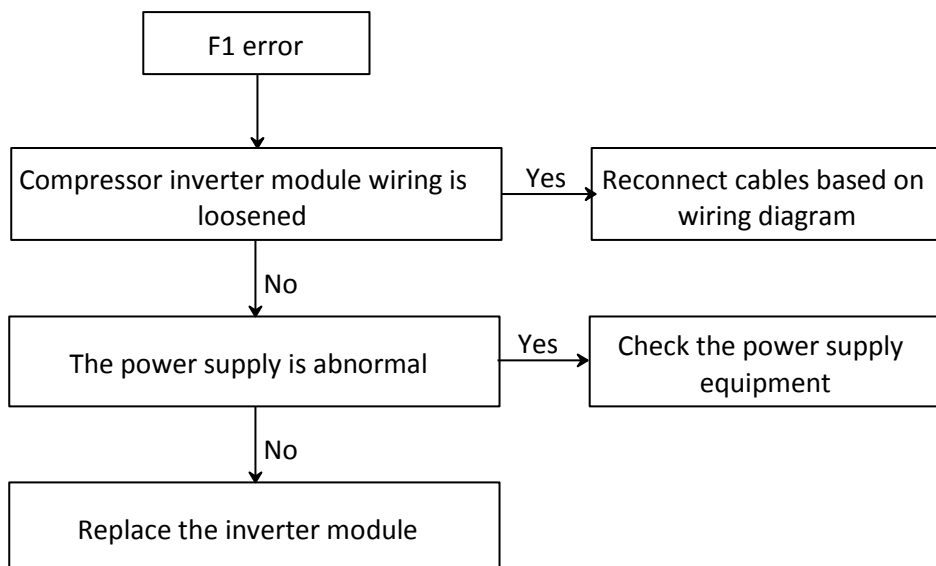

2.11 F6: Electronic expansion valve connection error

2.11.1 Digital display output

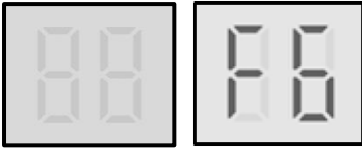

2.11.2 Description

- Electronic expansion valve connection error.
- All units stop running.
- Error code is only displayed on the unit with the error.

2.11.3 Trigger / recover condition

- Trigger condition: The main control board cannot receive the feedback signal of EXV.
- Recover condition: The main control board can receive the feedback signal of EXV.
- Reset method: When the main control board can receive the feedback signal of EXV, F6 flashes, a manual system restart is required before the system can resume operation.

2.11.4 Possible causes

- Electronic expansion valve coil not connected properly or has malfunctioned.
- Damaged main PCB.

2.11.5 Procedure

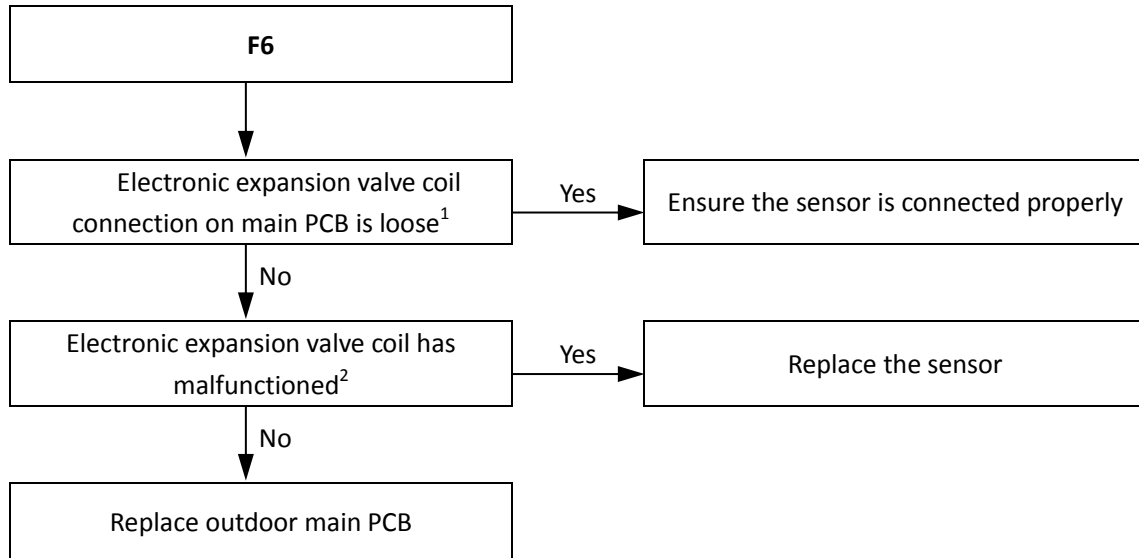

Notes:

1. Electronic expansion valve coil connections is port CN70 on the main PCB (labeled 19 in Figure 5-2.1 in Part 5, 2.1 “Ports”).
2. The normal resistances between EXV coil wiring terminals RED and white / yellow / orange / blue are 40-50Ω. If any of the resistances differ from the value, the EXV coil has malfunctioned.

Figure: EXV coil wiring terminals

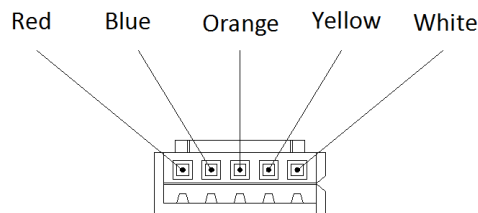

2.12 xH0: Communication error

2.12.1 Digital display output

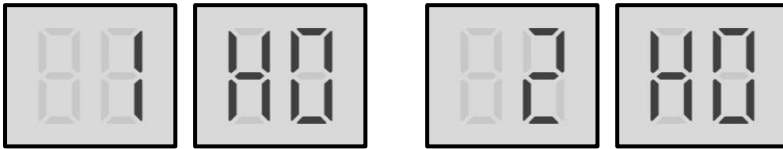

In the error code, 'x' is a placeholder for the compressor system (compressor and related electrical components), with 1 representing compressor system A and 2 representing compressor system B.

2.12.2 Description

- 1H0 indicates a communication error between the main control chip and the compressor A inverter driver chip.
- 2H0 indicates a communication error between the main control chip and the compressor B inverter driver chip.
- All units stop running.
- Error code is only displayed on the unit with the error.

2.12.3 Trigger / recover condition

- Trigger condition: Main control chip and inverter driver chip cannot communication for 2 minutes.
- Recover condition: Communication go back to normal.
- Reset method: Resume automatically.

2.12.4 Possible causes

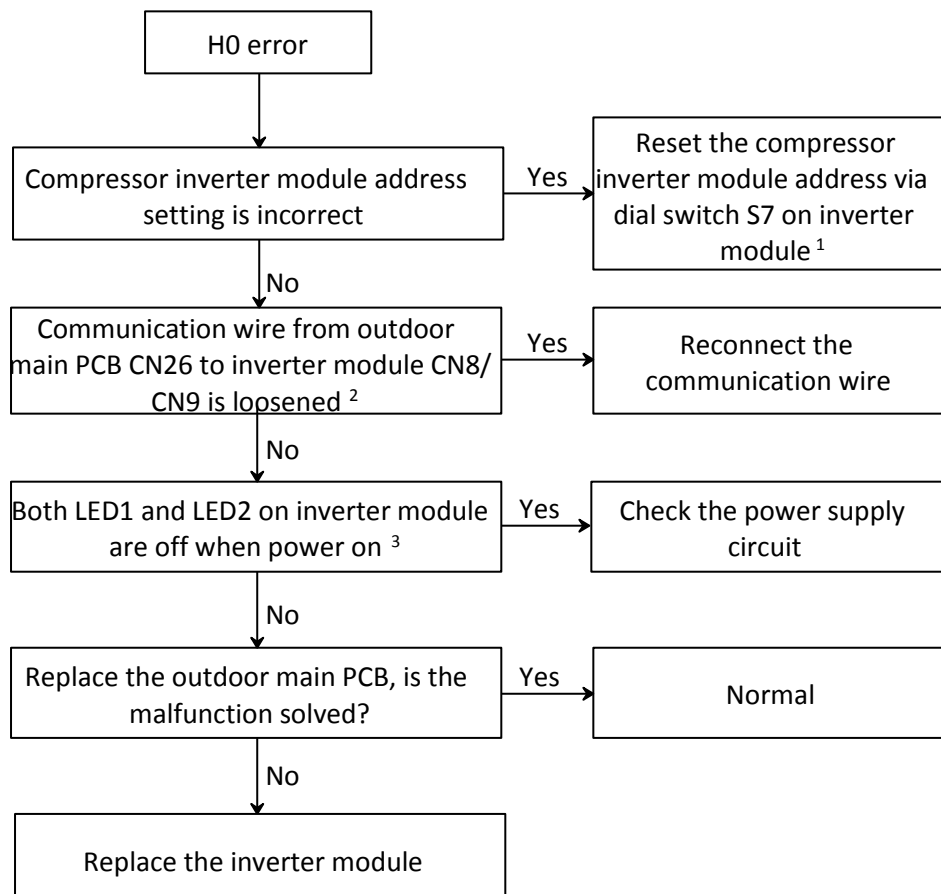

- Incorrect compressor inverter module address setting.
- Loosened communication wiring from the main PCB to the inverter module.
- Bridge rectifier damaged.
- Main PCB damaged.
- Compressor inverter module damaged.

2.12.5 Procedure



Notes:

1. Compressor inverter module address is set through dial switch S7 on the inverter module. The compressor inverter module A/B location refers to the wiring diagram.

S7 on inverter module	Inverter module address
	0 for compressor inverter module A
	1 for compressor inverter module B

2. Communication wire from outdoor main PCB CN26 to inverter module CN8/CN9.
3. LED1/2 on inverter module

2.13 H2, H3: Slave units decreased/increased

2.13.1 Digital display output

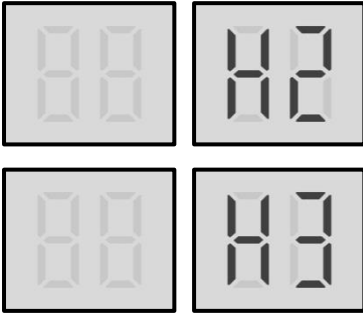

2.13.2 Description

- H2 indicates that the number of slave units detected by master unit has decreased.
- H3 indicates that the number of slave units detected by master unit has increased.
- All units stop running.
- Error code is only displayed on the master unit.

2.13.3 Trigger / recover condition

- Trigger condition: Number of slave units detected by master unit has decreased or increased.
- Recover condition: Number of slave units detected by master unit goes back to normal.
- Reset method: Resume automatically.

2.13.4 Possible causes

- Some outdoor units are powered off.
- Power supply abnormal.
- Incorrect outdoor unit address setting.
- Communication wires between outdoor units not connected properly.
- Loosened wiring within electric control box.
- Damaged main PCB or electric control box communication terminals block.

2.13.5 Procedure

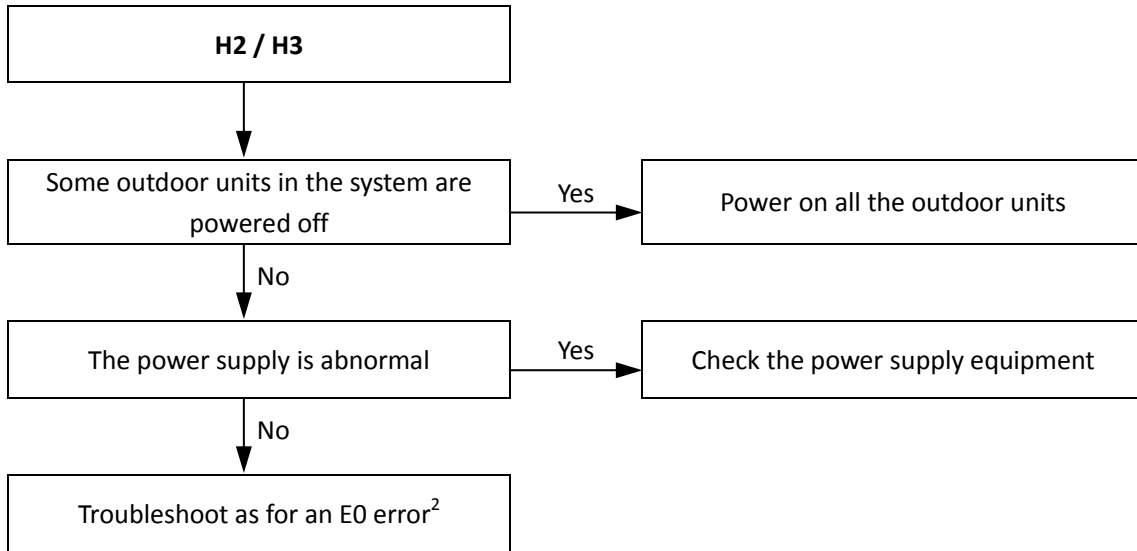

Notes:

1. See "E0 Troubleshooting".

2.14 xH4: Inverter module protection

2.14.1 Digital display output

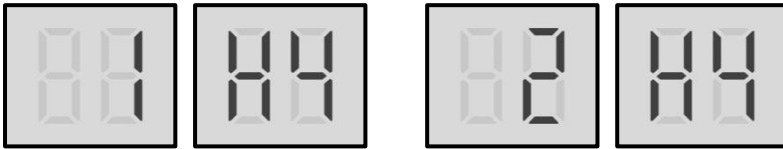

In the error code, 'x' is a placeholder for the compressor system (compressor and related electrical components), with 1 representing compressor system A and 2 representing compressor system B.

2.14.2 Description

- 1H4 indicates compressor A inverter module protection.
- 2H4 indicates compressor B inverter module protection.
- All units stop running.
- Error code is only displayed on the unit with the error.

2.14.3 Trigger / recover condition

- Trigger condition: Compressor appears three inverter module protections.
- Recover condition: Inverter module goes back to normal.
- Reset method: Manually restart.

2.14.4 Possible causes

- Inverter module protection.
- DC bus low or high voltage protection.
- MCE error.
- Zero speed protection.
- Phase sequence error.
- Excessive compressor frequency variation.
- Actual compressor frequency differs from target frequency.

2.14.5 Specific error codes for xH4 inverter module protection

If an xH4 error code is displayed, enter menu mode “n31” (refer to Part 5, 2.2.3 “menu mode”) to check the history error code to check the following specific error code: xL0, xL1, xL2, xL4, xL5, xL7, xL8, xL9.

Table 6-2.1: Specific error codes for error xH4

Specific error code ¹	Content
xL0	Inverter module protection
xL1	DC bus low voltage protection
xL2	DC bus high voltage protection
xL4	MCE error
xL5	Zero speed protection
xL7	Phase sequence error
xL8	Compressor frequency variation greater than 15Hz within one second protection
xL9	Actual compressor frequency differs from target frequency by more than 15Hz protection

Notes:

1. 'x' is a placeholder for the compressor system (compressor and related electrical components), with 1 representing compressor system A and 2 representing compressor system B.

TVR Pro CO 50/60Hz



The specific error codes xL0, xL1, xL2 and xL4 can also be obtained from the inverter module LED indicators. If an inverter module error has occurred, LED2 is continuously on and LED1 flashes.

Figure: LED indicators LED1 and LED2 on inverter module

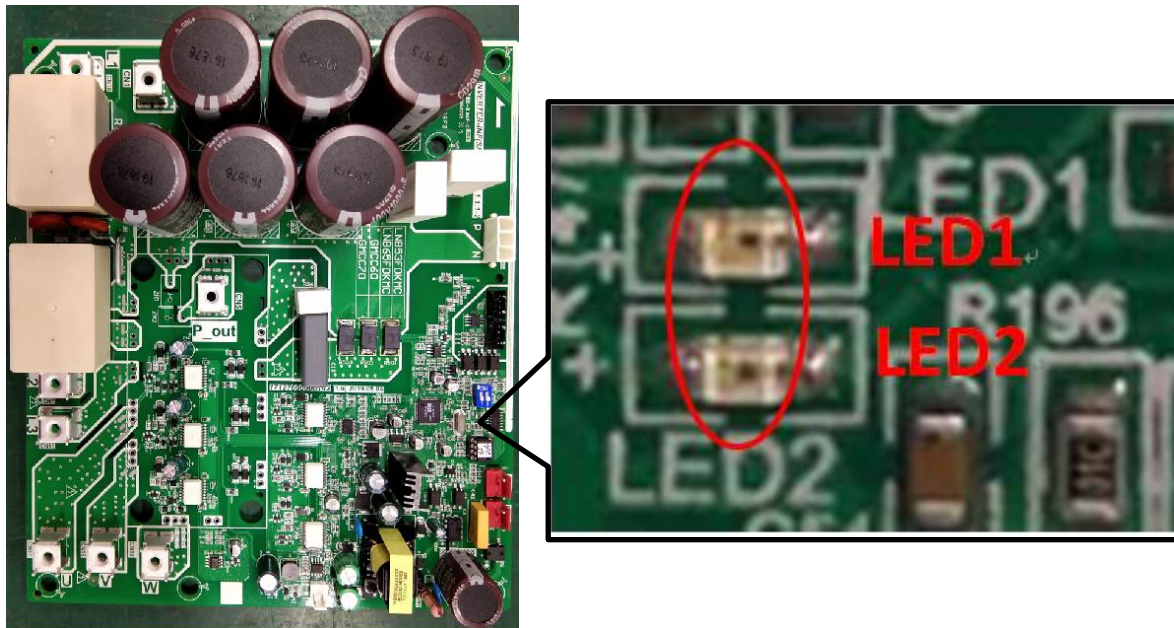
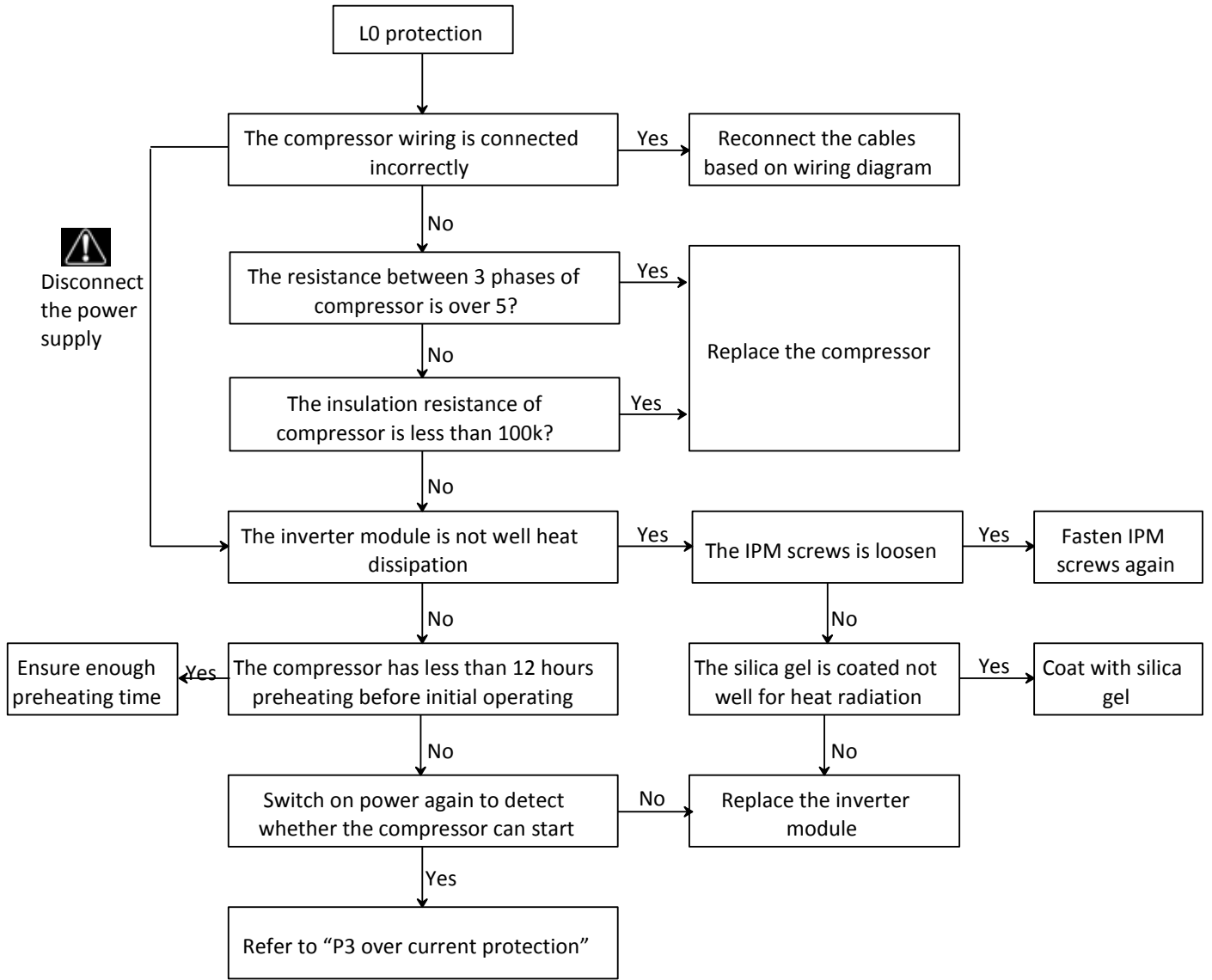

Table 5-3.2: Errors indicated on LED1

LED1 flashing pattern	Corresponding error
Flashes 8 times and stops for 1 second, then repeats	xL0 - Inverter module protection
Flashes 9 times and stops for 1 second, then repeats	xL1 - DC bus low voltage protection
Flashes 10 times and stops for 1 second, then repeats	xL2 - DC bus high voltage protection
Flashes 12 times and stops for 1 second, then repeats	xL4 - MCE error
Flashes 13 times and stops for 1 second, then repeats	xL5- Zero speed protection
Flashes 15 times and stops for 1 second, then repeats	xL7- Phase sequence error
Flashes 16 times and stops for 1 second, then repeats	xL8-Compressor frequency variation greater than 15Hz within one second protection
Flashes 17 times and stops for 1 second, then repeats	xL9-Actual compressor frequency differs from target frequency by more than 15Hz protection

2.14.6 L0: Inverter module protection



2.14.7 L1: DC bus low voltage protection

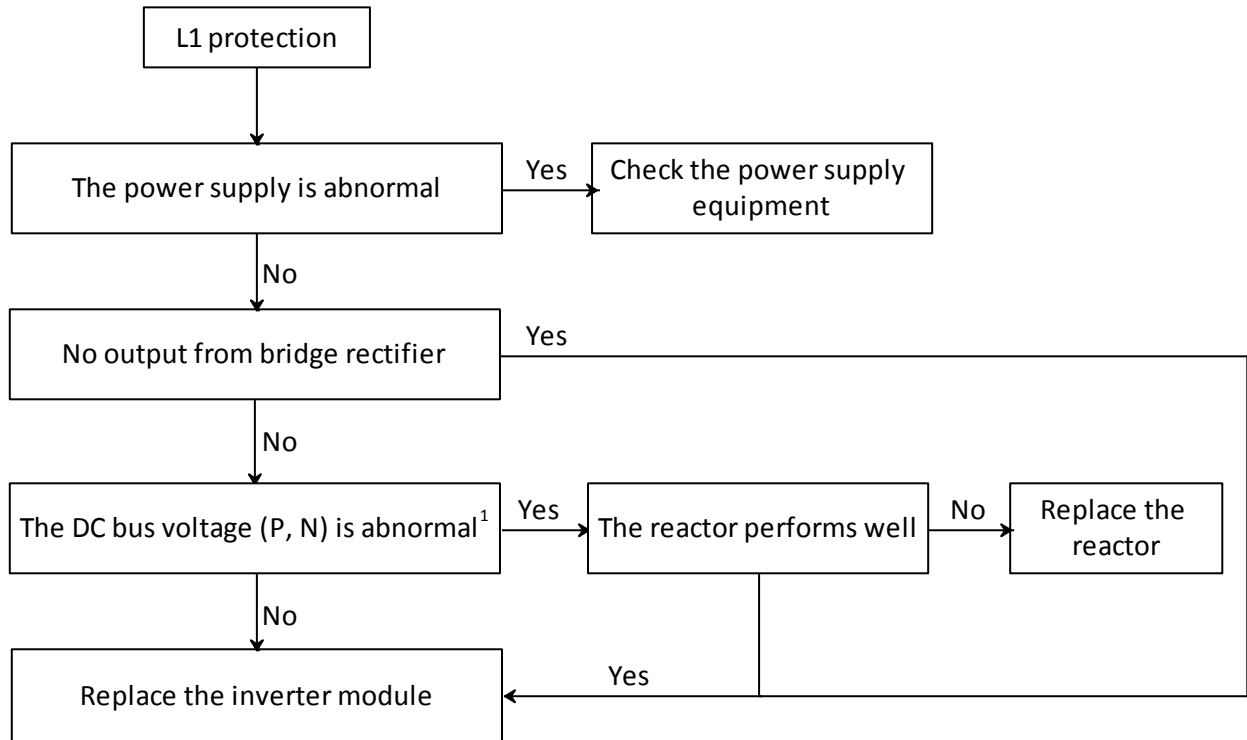

- Note:
1. The normal DC voltage between terminals P and N on inverter module should be 450-650V. When the voltage is lower than 350V, L1 protection will be appeared.

Figure: Inverter module terminals

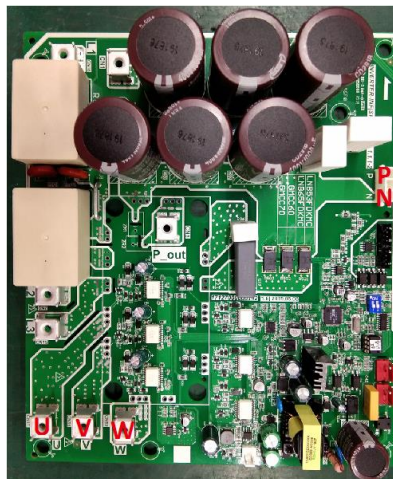

2.14.8 L2: DC bus high voltage protection

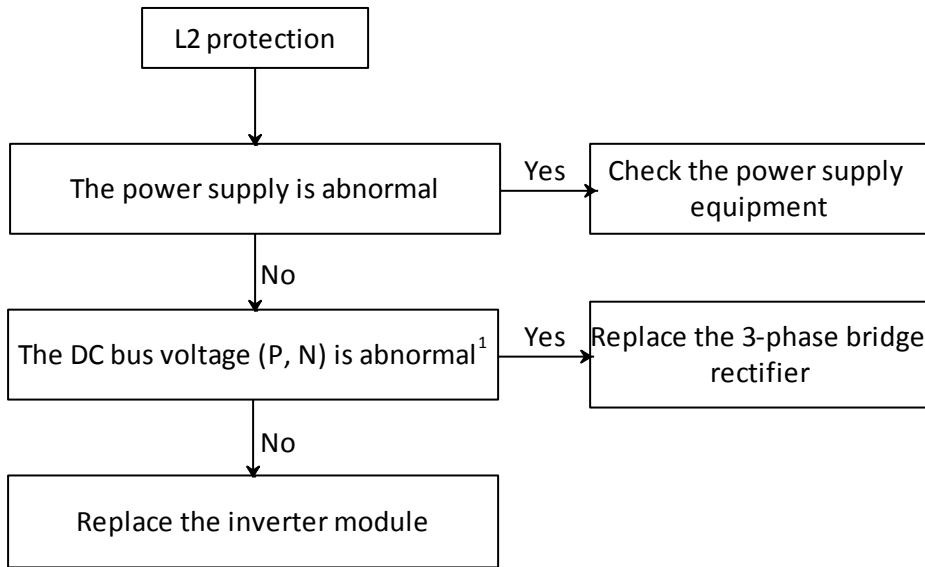

- Note:
1. The normal DC voltage between terminals P and N on inverter module should be 450-650V. When the voltage is higher than 700V, L2 protection will be appeared.

Figure: Inverter module terminals

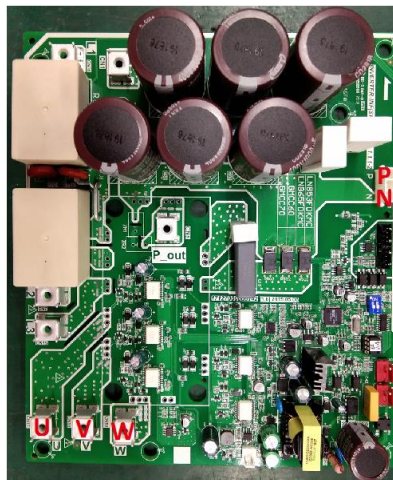

2.14.9 L4: MCE error



Disconnect the power supply

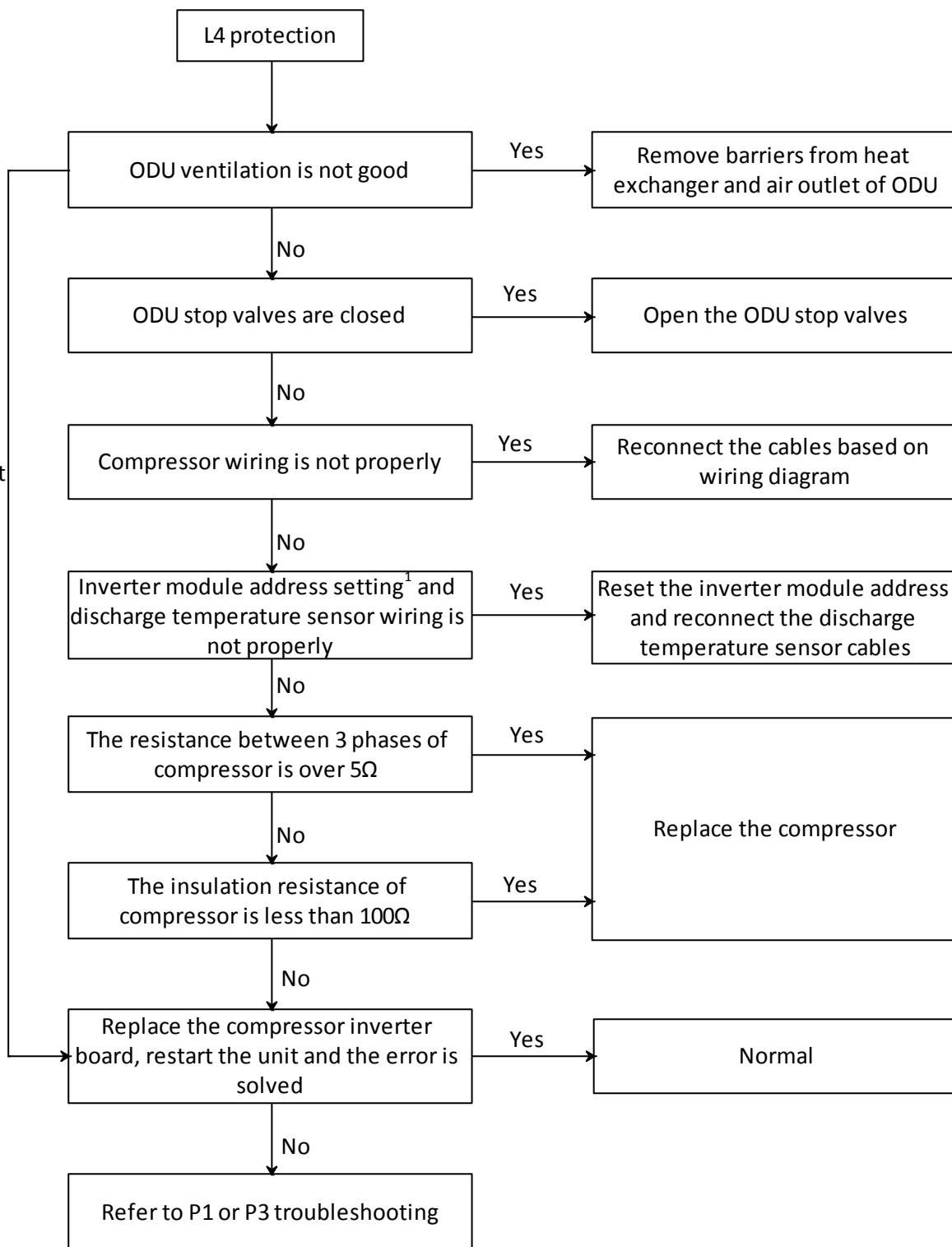

- Notes:
- Compressor inverter module address is set through dial switch S7 on the inverter module. The compressor inverter module A/B location refers to the wiring diagram.

S7 on inverter module	Inverter module address
	0 for compressor inverter module A
	1 for compressor inverter module B

2.14.10 L7: Phase sequence error

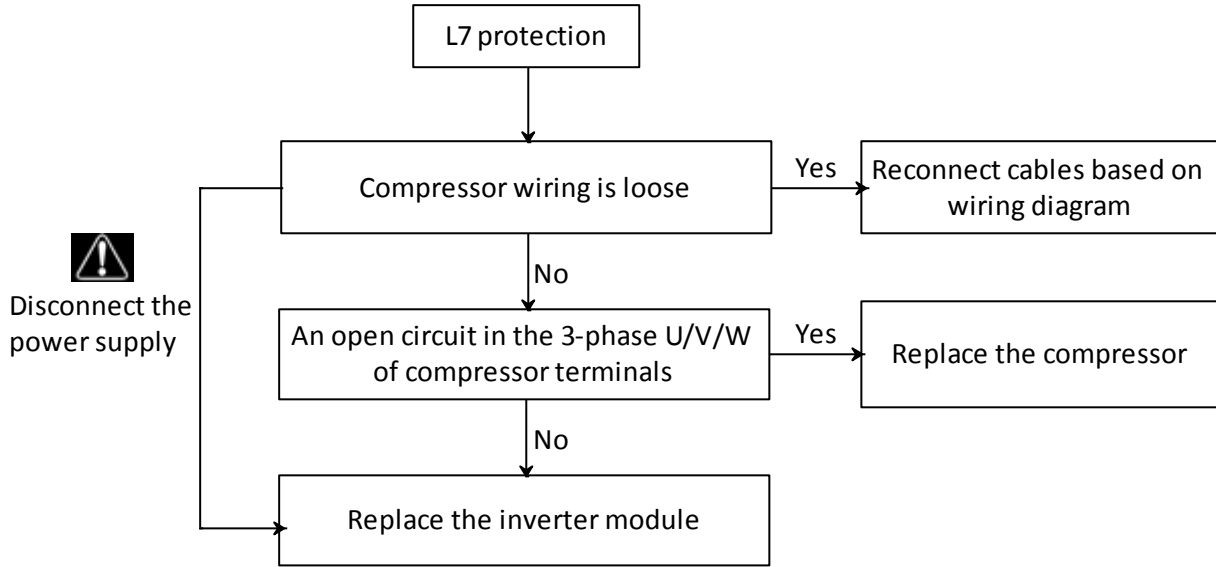

2.14.11 L8: Compressor frequency variation greater than 15Hz within one second protection

L9: Actual compressor frequency differs from target frequency by more than 15Hz protection

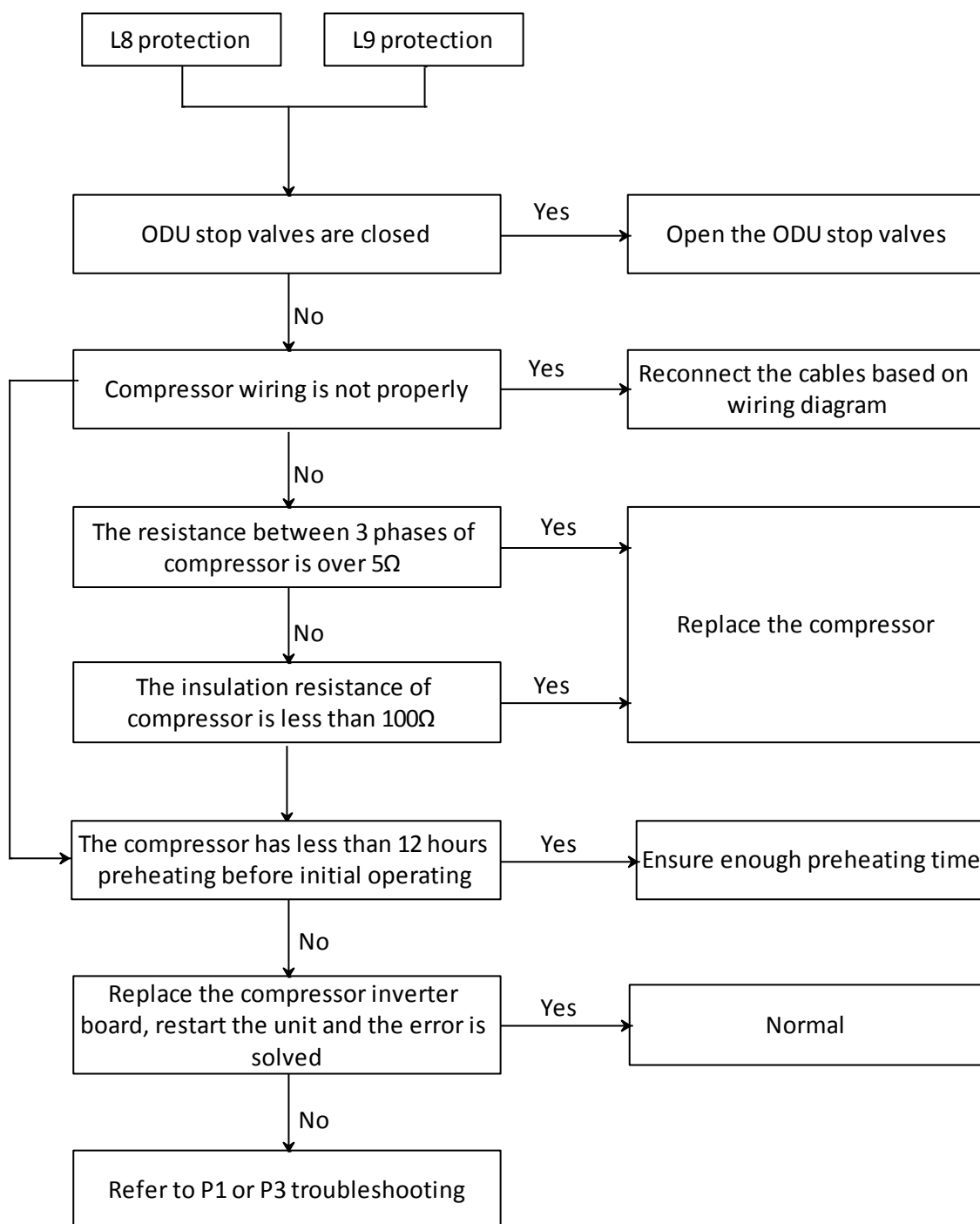

Disconnect the power supply

2.14.12 Compressor replacement procedure

Step 1: Remove faulty compressor and remove oil

- Remove the faulty compressor from the outdoor unit.
- Before removing the oil, shake the compressor so as to not allow impurities to remain settled at the bottom.
- Drain the oil out of the compressor and retain it for inspection. Normally the oil can be drained out from the compressor discharge pipe.

Step 2: Inspect oil from faulty compressor

- The oil should be clear and transparent. Slightly yellow oil is not an indication of any problems. However, if the oil is dark, black or contains impurities, the system has problems and the oil needs to be changed. If the compressor oil has been spoiled, the compressor will not be being lubricated effectively. Abrasion will lead to a larger load and higher current. More electric energy will get dissipated as heat and the temperature of the motor will become increasingly high. Finally, compressor damage or burnout will result.

Step 3: Check oil in other compressors in the system

- If the oil drained from the faulty compressor is clean, go to Step 6.
- If the oil drained from the faulty compressor is only lightly spoiled, go to Step 4.
- If the oil drained from the faulty compressor is heavily spoiled, check the oil in the other compressors in the system. Drain the oil from any compressors where the oil has been spoiled. Go to Step 4.

Step 4: Replace oil separator(s) and accumulator(s)

- If the oil from a compressor is spoiled (lightly or heavily), drain the oil from the oil separator and accumulator in that unit and then replace them.

Step 5: Check filters(s)

- If the oil from a compressor is spoiled (lightly or heavily), check the filter between the gas stop valve and the 4-way valve in that unit. If it is blocked, clean with nitrogen or replace.

Step 6: Replace the faulty compressor and re-fit the other compressors

- Replace the faulty compressor.
- If the oil had been spoiled and was drained from the non-faulty compressors in Step 3, use clean oil to clean them before re-fitting them into the units. To clean, add oil into the compressor through the discharge pipe using a funnel, shake the compressor, and then drain the oil. Repeat several times and then re-fit the compressors into the units. (The discharge pipe is connected to the oil pool of the compressor by the inner oil balance pipe.)

Step 7: Add compressor oil

- Add 2.3L of oil to each of the compressors from which oil was drained in Step 3.
- Only use FV50S oil. Different compressors require different types of oil. Using the wrong type of oil leads to various problems.
- Add additional oil to the accumulators such that the total amount of oil is 4L in 8-12HP units, 5L in 14-16HP units 6L in 18-22HP units and 9L in 24-30HP units.

Step 8: Vacuum drying and refrigerant charging

- Once all the compressors and other components have been fully connected, vacuum dry the system and recharge refrigerant. Refer to the V6 Engineering Data Book, Part 3.

2.15 H7: Unmatched total number of indoor units

2.15.1 Digital display output

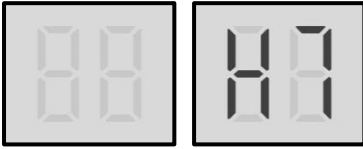

2.15.2 Description

- Number of indoor units detected by master unit not same as number set on main PCB.
- All units stop running.
- Error code is only displayed on the master unit.

2.15.3 Trigger / recover condition

- Trigger condition: Only one indoor unit cannot be detected by master unit for 8 hours or more than one indoor unit cannot be detected by master unit for 3 minutes.
- Recover condition: Number of indoor units detected by master unit is same as number set on main PCB.
- Reset method: Resume automatically.

2.15.4 Possible causes

- Number of indoor units set on main PCB not same as actual number of indoor units.
- Some indoor units are powered off.
- Communication wires between indoor and outdoor units not connected properly.
- Indoor unit PCB damaged.
- Indoor unit without address or indoor unit address duplicated.
- Main PCB damaged.

2.15.5 Procedure

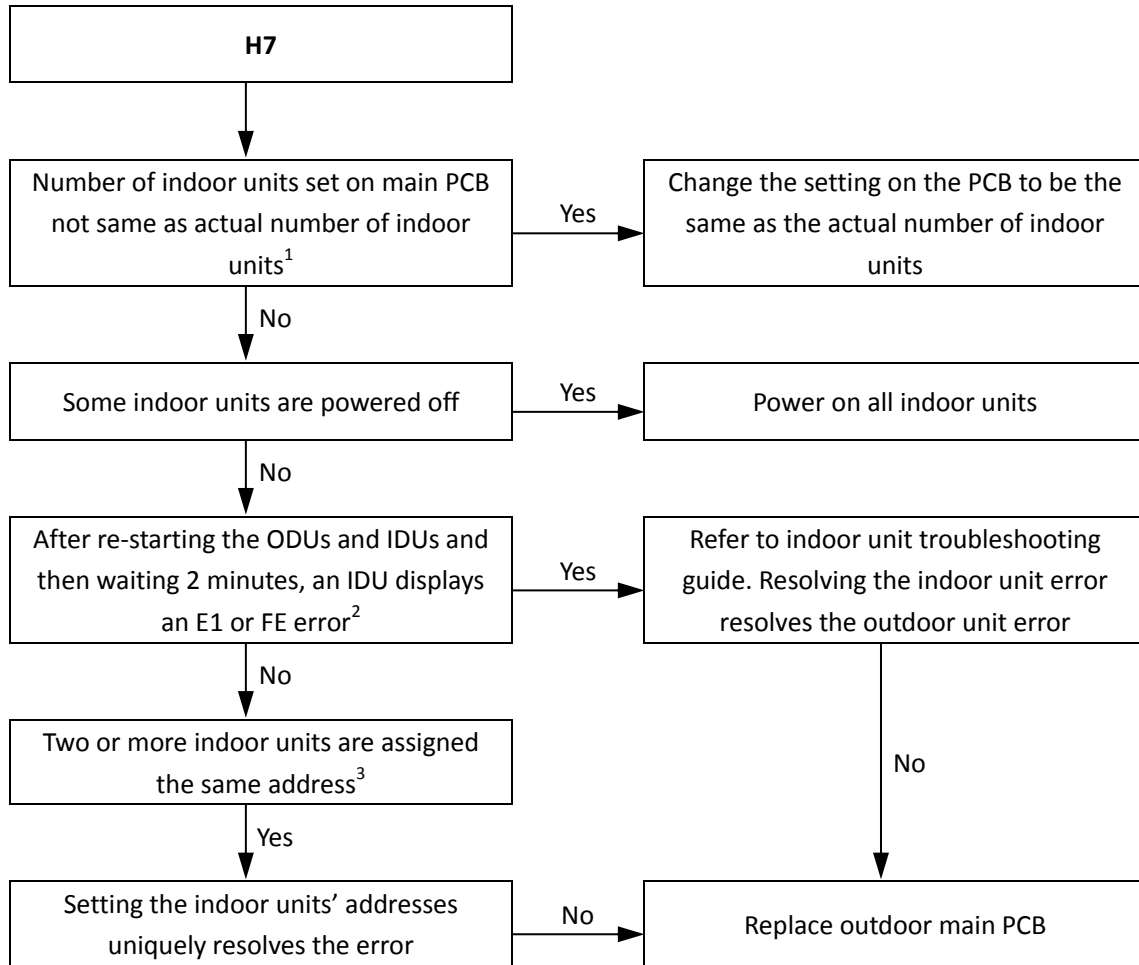

Notes:

1. The number of indoor units can be set on switches EN3 and S12 on the main PCB.
2. Indoor unit error code E1 indicates a communication error between indoor and master unit. Indoor unit error code FE indicates that an indoor unit has not been assigned an address.
3. Indoor unit addresses can be checked and manually assigned using indoor unit remote/wired controllers. Alternatively, indoor unit addresses can be automatically assigned by the master outdoor unit.

2.16 H8: High pressure sensor error

2.16.1 Digital display output

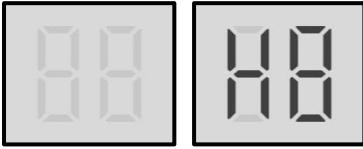

2.16.2 Description

- High pressure sensor error.
- All units stop running.
- Error code is only displayed on the unit with the error.

2.16.3 Trigger / recover condition

- Trigger condition: Discharge pressure $\leq 0.3\text{MPa}$.
- Recover condition: Discharge pressure $> 0.3\text{MPa}$.
- Reset method: Resume automatically.

2.16.4 Possible causes

- Pressure sensor not connected properly or has malfunctioned.
- Insufficient refrigerant.
- Low pressure side blockage.
- Poor evaporator heat exchange.
- Main PCB damaged.

2.16.5 Procedure

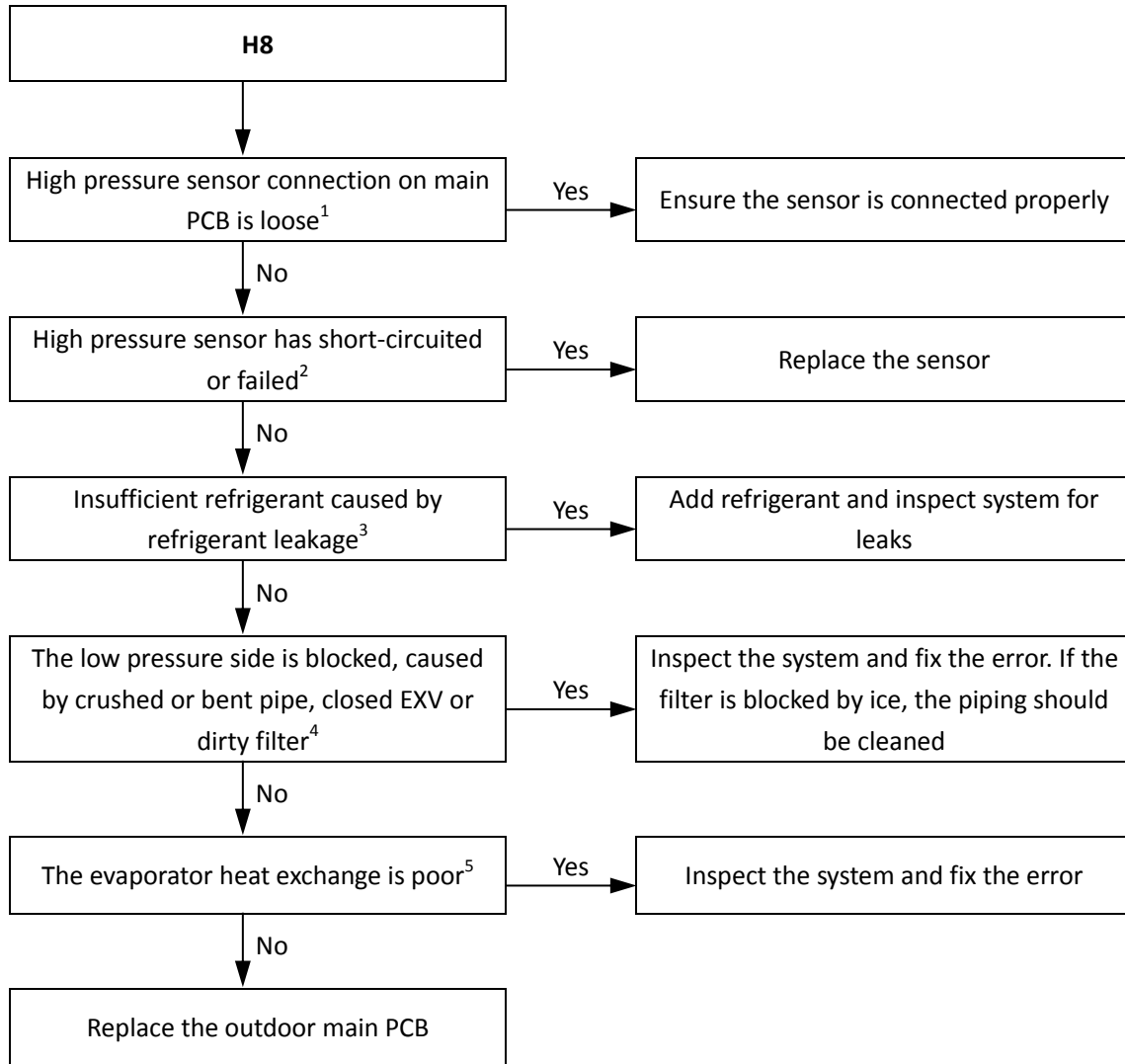

Notes:

1. High pressure sensor connection is port CN17 on the main PCB (labeled 7 in Figure 5-2.1 in Part 5, 2.1 "Ports").
2. Measure the resistance among the three terminals of the pressure sensor. If the resistance is of the order of mega Ohms or infinite, the pressure sensor has failed.
3. An insufficiency of refrigerant causes compressor discharge temperature to be higher than normal, discharge and suction pressures to be lower than normal and compressor current to be lower than normal, and may cause frosting to occur on the suction pipe. These issues disappear once sufficient refrigerant has been charged into the system. For normal system parameters refer to Table 6-3.4 in Part 6, 3.2 "Normal Operating Parameters of Refrigerant System".
4. A low pressure side blockage causes compressor discharge temperature to be higher than normal, suction pressure to be lower than normal and compressor current to be lower than normal, and may cause frosting to occur on the suction pipe. For normal system parameters refer to Table 6-3.4 in Part 6, 3.2 "Normal Operating Parameters of Refrigerant System".
5. In cooling mode check indoor heat exchangers, fans and air outlets for dirt/blockages. In heating mode check outdoor heat exchangers, fans and air outlets for dirt/blockages.

2.17 yHd: Slave unit malfunction

2.17.1 Digital display output

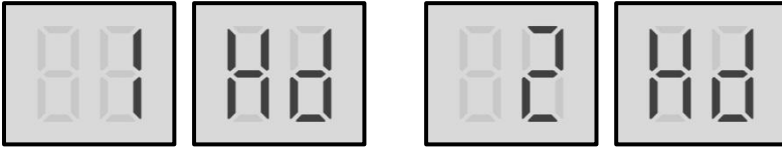

In the error code, 'y' is a placeholder for the address (1 or 2) of the slave unit with the error.

2.17.2 Description

- 1Hd indicates an error on the slave unit with address 1.
- 2Hd indicates an error on the slave unit with address 2.
- All units stop running.
- Error code is only displayed on the master unit.

2.17.3 Trigger / recover condition

- Trigger condition: Slave unit is malfunction.
- Recover condition: Slave unit goes back to normal.
- Reset method: Resume automatically.

2.17.4 Possible causes

- Slave unit malfunction.

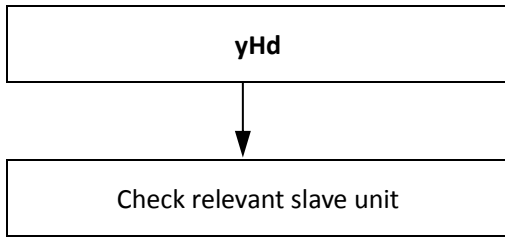
2.17.5 Procedure

2.18 P1: Discharge pipe high pressure protection

2.18.1 Digital display output

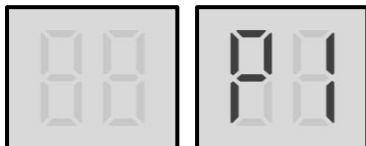

2.18.2 Description

- All units stop running.
- Error code is only displayed on the unit with the error.

2.18.3 Trigger / recover condition

- Trigger condition: Discharge pressure ≥ 4.3 MPa.
- Recover condition: Discharge pressure ≤ 4.0 MPa for 2 minutes.
- Reset method: Resume automatically.

2.18.4 Possible causes

- Outdoor unit stop valves are closed.
- High pressure sensor not connected properly or has malfunctioned.
- Excess refrigerant.
- System contains air or nitrogen.
- High pressure side blockage.
- Poor condenser heat exchange.
- Main PCB damaged.

2.18.5 Procedure

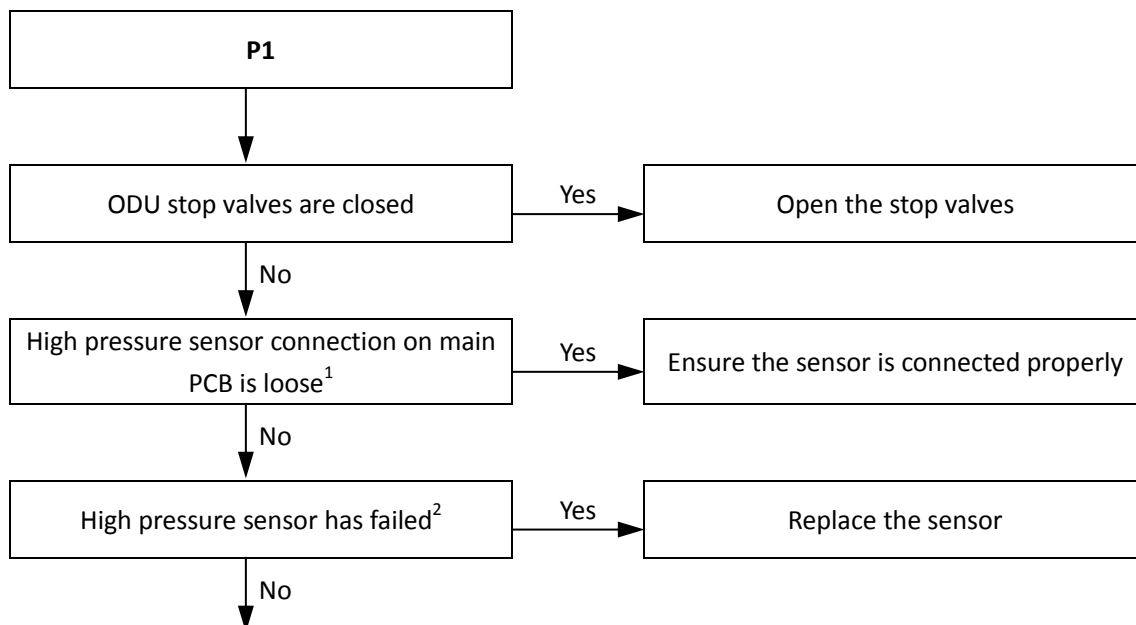

Flowchart continued on next page ...

... flowchart continued from previous page

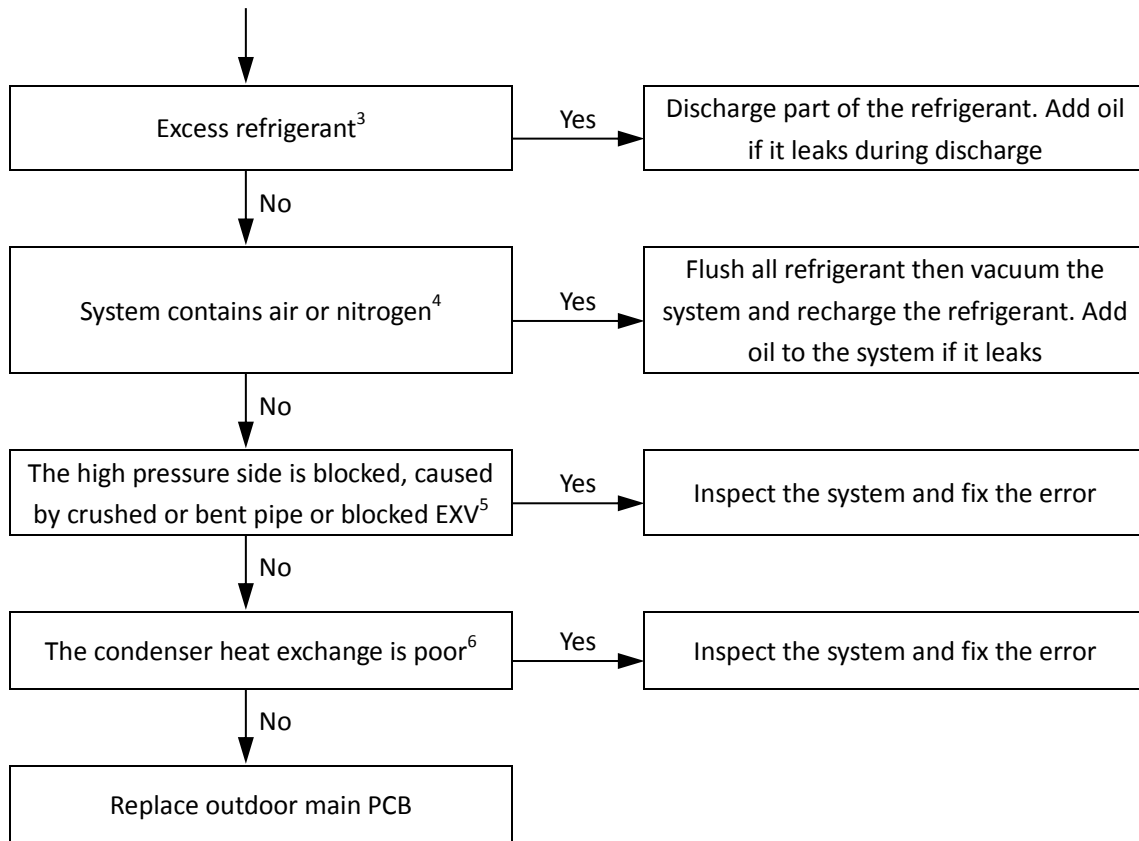

Notes:

1. The high pressure sensor connection is port CN17 on the main PCB (labeled 7 in Figure 5-2.1 in Part 5, 2.1 "Ports").
2. Measure the resistance among the three terminals of the high pressure sensor. If the resistance is of the order of mega Ohms or infinite, the high pressure sensor has failed.
3. Excess refrigerant causes discharge temperature to be lower than normal, discharge pressure to be higher than normal and suction pressure to be higher than normal. For normal system parameters refer to Table 6-3.4 in Part 6, 3.2 "Normal Operating Parameters of Refrigerant System".
4. Air or nitrogen in the system causes discharge temperature to be higher than normal, discharge pressure to be higher than normal, compressor current to be higher than normal, abnormal compressor noise and an unsteady pressure meter reading. For normal system parameters refer to Table 6-3.4 in Part 6, 3.2 "Normal Operating Parameters of Refrigerant System".
5. High pressure side blockage causes discharge temperature to be higher than normal, discharge pressure to be higher than normal and suction pressure to be lower than normal. For normal system parameters refer to Table 6-3.4 in Part 6, 3.2 "Normal Operating Parameters of Refrigerant System".
6. In cooling mode check outdoor heat exchangers, fans and air outlets for dirt/blockages. In heating mode check indoor heat exchangers, fans and air outlets for dirt/blockages.

2.19 P2, H5: Suction pipe low pressure protection

2.19.1 Digital display output

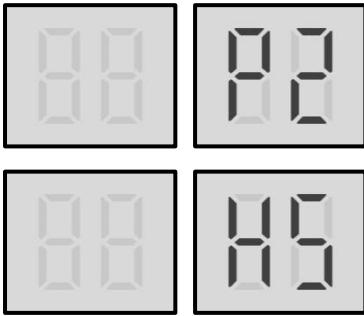

2.19.2 Description

- All units stop running.
- Error code is only displayed on the unit with the error.

2.19.3 Trigger / recover condition

- Trigger condition:
 - For P2 protection: Suction pressure $\leq 0.05\text{MPa}$.
 - For H5 protection: P2 protection appears three times in 60 minutes.
- Recover condition: Suction pressure $\geq 0.15\text{MPa}$.
- Reset method:
 - For P2 protection: Resume automatically.
 - For H5 protection: Manually restart.

2.19.4 Possible causes

- Outdoor unit stop valves are closed.
- Insufficient refrigerant.
- Low pressure side blockage.
- Poor evaporator heat exchange.
- Main PCB damaged.

2.19.5 Procedure

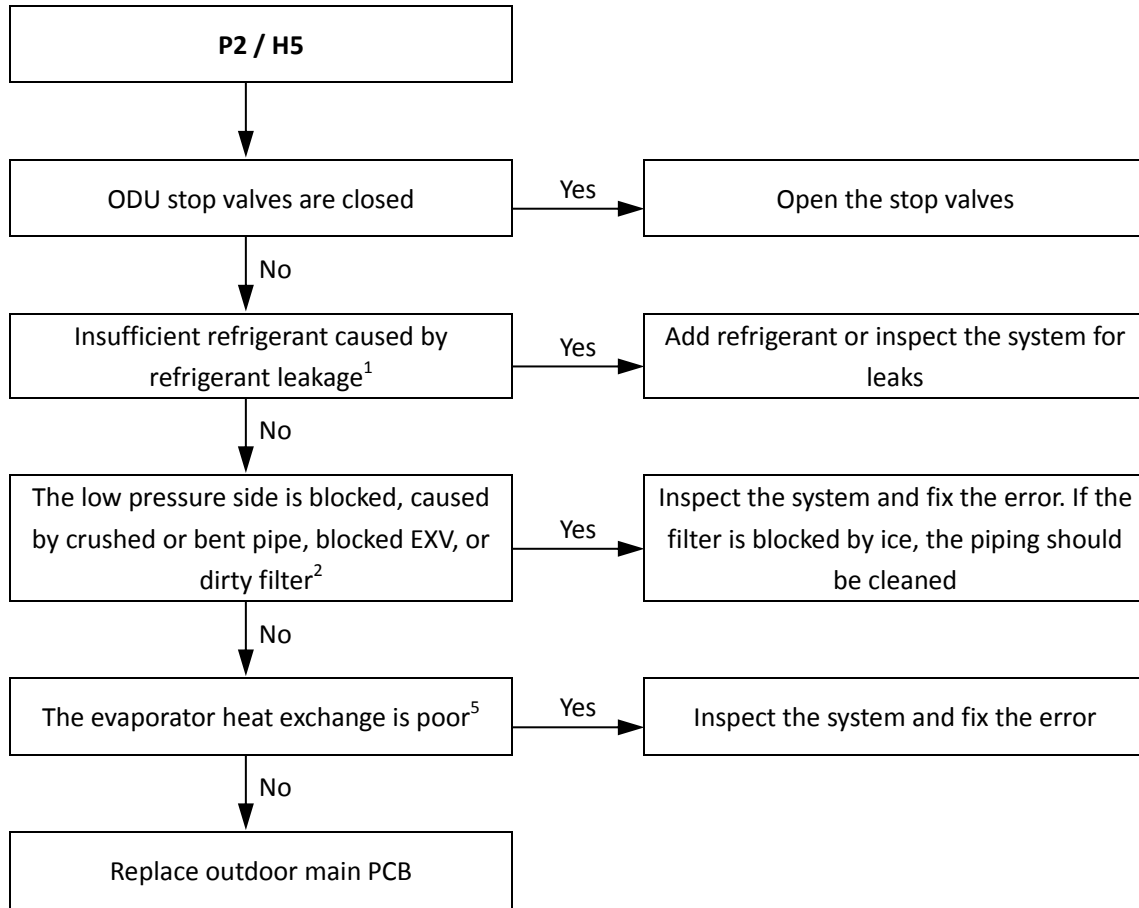

Notes:

1. An insufficiency of refrigerant causes compressor discharge temperature to be higher than normal, discharge and suction pressures to be lower than normal and compressor current to be lower than normal, and may cause frosting to occur on the suction pipe. These issues disappear once sufficient refrigerant has been charged into the system. For normal system parameters refer to Table 6-3.4 in Part 6, 3.2 "Normal Operating Parameters of Refrigerant System".
2. A low pressure side blockage causes compressor discharge temperature to be higher than normal, suction pressure to be lower than normal and compressor current to be lower than normal, and may cause frosting to occur on the suction pipe. For normal system parameters refer to Table 6-3.4 in Part 6, 3.2 "Normal Operating Parameters of Refrigerant System".
3. In cooling mode check indoor heat exchangers, fans and air outlets for dirt/blockages. In heating mode check outdoor heat exchangers, fans and air outlets for dirt/blockages.

2.20 P4, H6: Discharge temperature protection

2.20.1 Digital display output

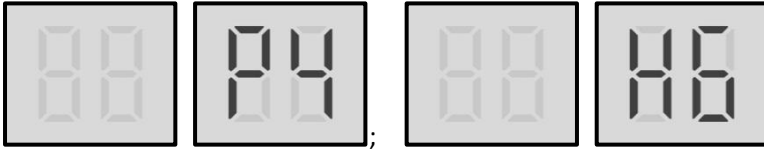

2.20.2 Description

- Discharge temperature protection.
- All units stop running.
- Error code is only displayed on the unit with the error.

2.20.3 Trigger / recover condition

- Trigger condition:
 - For P4 protection: Discharge temperature (T7C1/2) $\geq 120^{\circ}\text{C}$.
 - For H6 protection: P4 protection appears three times in 100 minutes.
- Recover condition: Discharge temperature (T7C1/2) $\leq 90^{\circ}\text{C}$.
- Reset method:
 - For P4 protection: Resume automatically.
 - For H6 protection: Manually restart.

2.20.4 Possible causes

- Outdoor unit stop valves are closed.
- Temperature sensor/switch not connected properly or has malfunctioned.
- Insufficient refrigerant.
- System blockage.
- Indoor load too large.
- System contains air or nitrogen.
- Poor condenser heat exchange.
- Main PCB damaged.

2.20.5 Procedure

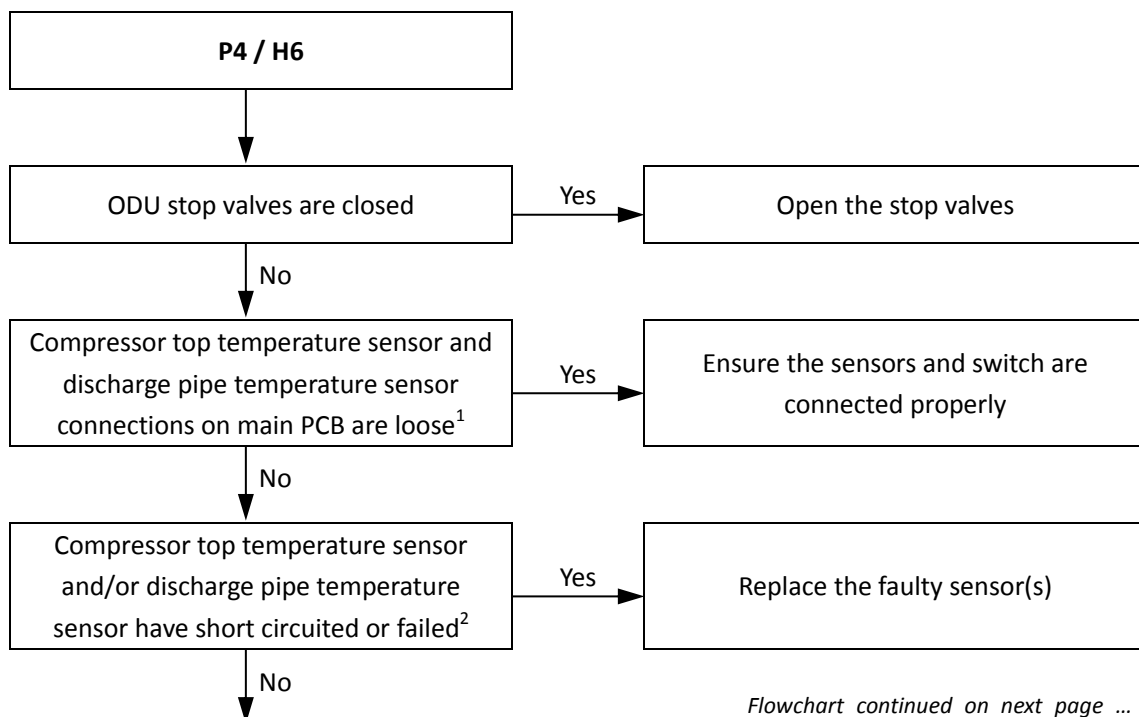

... flowchart continued from previous page

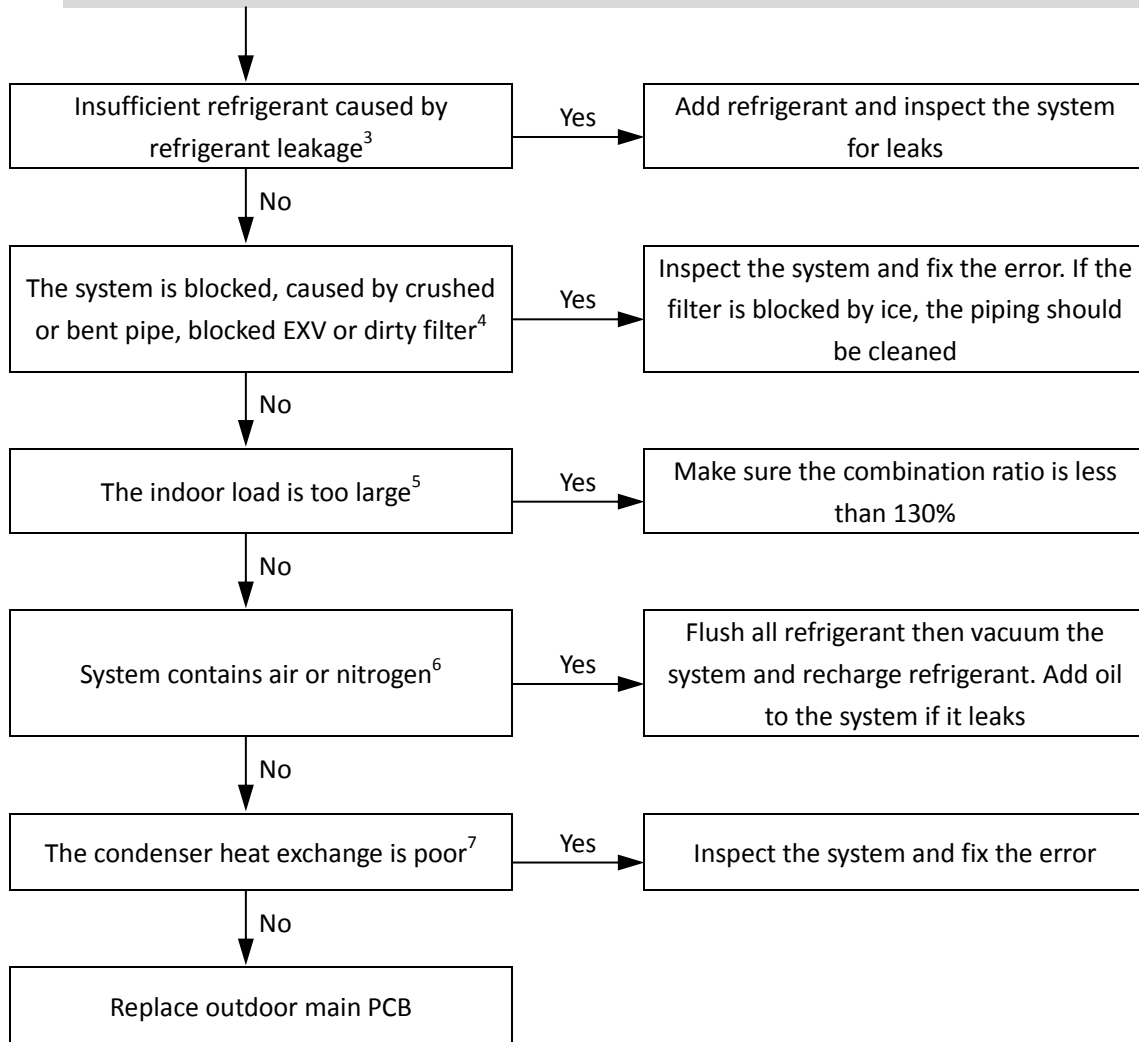
Notes:

1. Compressor top temperature sensor and discharge pipe temperature sensor connections are ports CN4 and CN5 on the main PCB (labeled 3 and 4, respectively, in Figure 5-2.1 in Part 5, 2.1 "Ports").
2. Measure sensor resistance. If the resistance is too low, the sensor has short-circuited. If the resistance is not consistent with the sensor's resistance characteristics table, the sensor has failed. Refer to Table 6-3.2 in Part 6, 3.1 "Temperature Sensor Resistance Characteristics".
3. An insufficiency of refrigerant causes compressor discharge temperature to be higher than normal, discharge and suction pressures to be lower than normal and compressor current to be lower than normal, and may cause frosting to occur on the suction pipe. These issues disappear once sufficient refrigerant has been charged into the system. For normal system parameters refer to Table 6-3.4 in Part 6, 3.2 "Normal Operating Parameters of Refrigerant System".
4. A low pressure side blockage causes compressor discharge temperature to be higher than normal, suction pressure to be lower than normal and compressor current to be lower than normal, and may cause frosting to occur on the suction pipe. For normal system parameters refer to Table 6-3.4 in Part 6, 3.2 "Normal Operating Parameters of Refrigerant System".
5. An indoor load that is too large causes suction and discharge temperatures to be higher than normal. For normal system parameters refer to Table 6-3.4 in Part 6, 3.2 "Normal Operating Parameters of Refrigerant System".
6. Air or nitrogen in the system causes discharge temperature to be higher than normal, discharge pressure to be higher than normal, compressor current to be higher than normal, abnormal compressor noise and an unsteady pressure meter reading. For normal system parameters refer to Table 6-3.4 in Part 6, 3.2 "Normal Operating Parameters of Refrigerant System".
7. In cooling mode check outdoor heat exchangers, fans and air outlets for dirt/blockages. In heating mode check indoor heat exchangers, fans and air outlets for dirt/blockages.

2.21 P5: Outdoor heat exchanger temperature protection

2.21.1 Digital display output

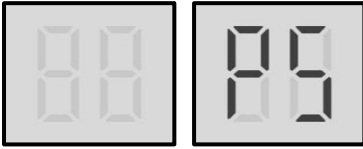

2.21.2 Description

- Outdoor heat exchanger temperature protection.
- All units stop running.
- Error code is only displayed on the unit with the error.

2.21.3 Trigger / recover condition

- Trigger condition: Outdoor heat exchanger temperature (T3) $\geq 65^{\circ}\text{C}$.
- Recover condition: Outdoor heat exchanger temperature (T3) $< 55^{\circ}\text{C}$.
- Reset method: Resume automatically.

2.21.4 Possible causes

- Outdoor unit stop valves are closed.
- Temperature sensor not connected properly or has malfunctioned.
- Indoor load too large.
- System contains air or nitrogen.
- Poor condenser heat exchange.
- High pressure side blockage.
- Main PCB damaged.

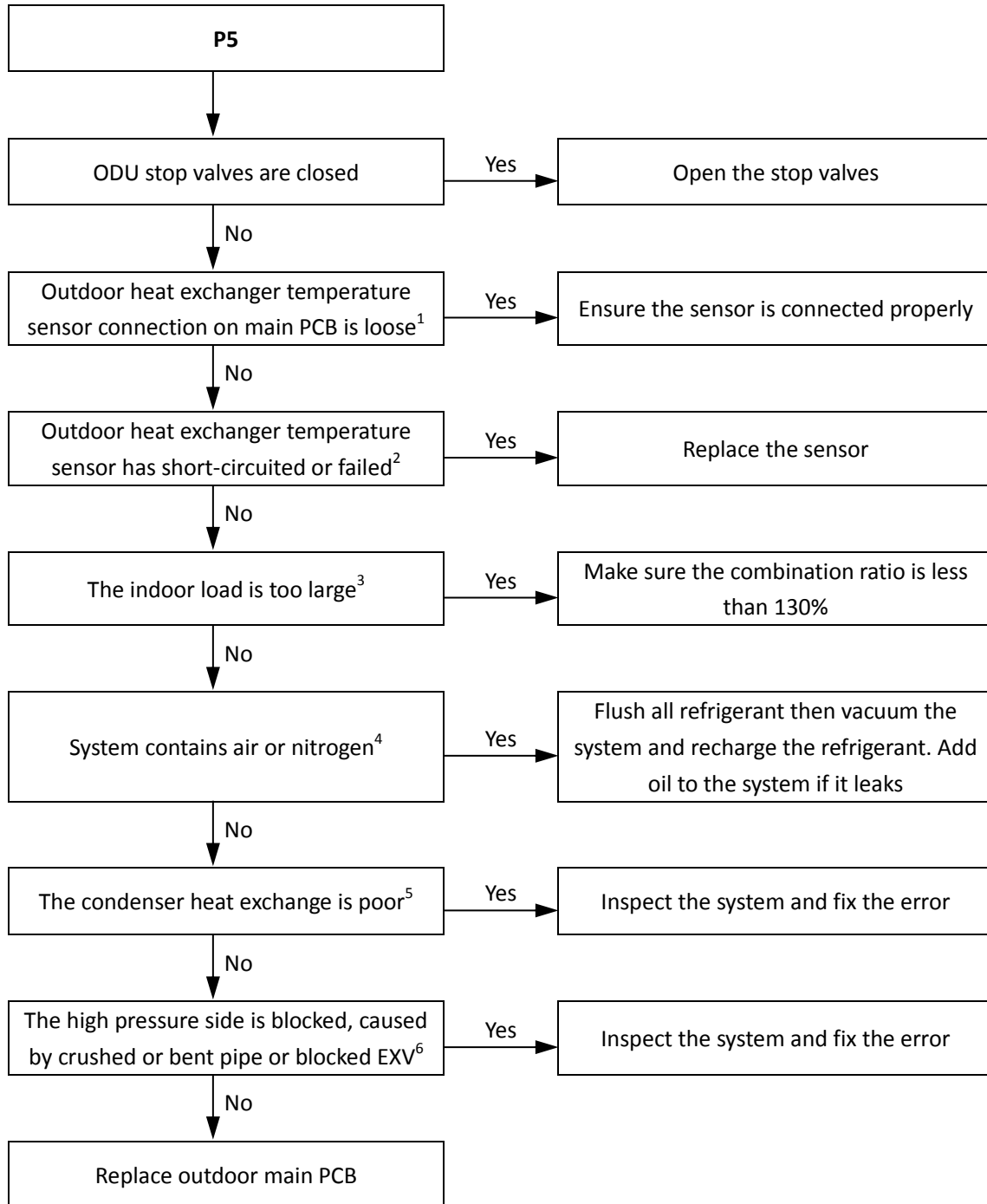
2.21.5 Procedure

Notes:

1. Outdoor heat exchanger temperature sensor connection is port CN1 on the main PCB (labeled 11 in Figure 5-2.1 in Part 5, 2.1 "Ports").
2. Measure sensor resistance. If the resistance is too low, the sensor has short-circuited. If the resistance is not consistent with the sensor's resistance characteristics table, the sensor has failed. Refer to Table 6-3.1 in Part 6, 3.1 "Temperature Sensor Resistance Characteristics"
3. An indoor load that is too large causes suction and discharge temperatures to be higher than normal. For normal system parameters refer to Table 6-3.4 in Part 6, 3.2 "Normal Operating Parameters of Refrigerant System".
4. Air or nitrogen in the system causes discharge temperature to be higher than normal, discharge pressure to be higher than normal, compressor current to be higher than normal, abnormal compressor noise and an unsteady pressure meter reading. For normal system parameters refer to Table 6-3.4 in Part 6, 3.2 "Normal Operating Parameters of Refrigerant System".
5. In cooling mode check outdoor heat exchangers, fans and air outlets for dirt/blockages. In heating mode check indoor heat exchangers, fans and air outlets for dirt/blockages.
6. High pressure side blockage causes discharge temperature to be higher than normal, discharge pressure to be higher than normal and suction pressure to be lower than normal. For normal system parameters refer to Table 6-3.4 in Part 6, 3.2 "Normal Operating Parameters of Refrigerant System".

2.22 xP9, xH9: Fan module protection

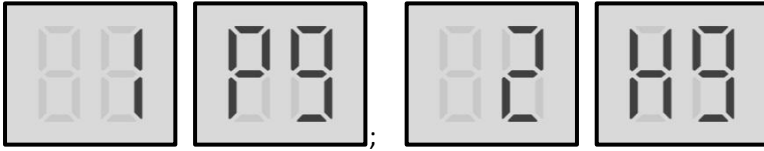
2.22.1 Digital display output



'x' is a placeholder for the fan motor system (fan motor and related electrical components), with 1 representing fan motor system A and 2 representing fan motor system B.

2.22.2 Description

- Fan module protection.
- All units stop running.
- Error code is only displayed on the unit with the error.

2.22.3 Trigger / recover condition

- Trigger condition:
For P9 protection: Fan speed is too low.
For H9 protection: P9 protection appears ten times in 120 minutes.
- Recover condition: Fan speed go back to normal.
- Reset method:
For P9 protection: Resume automatically; For H9 protection: Manually restart.

2.22.4 Possible causes

- Switch ENC2 incorrectly set.
- Power or communication wires not connected properly.
- Fan motor blocked or has failed.
- Power supply abnormal.
- AC filter board damaged.
- Fan module damaged.
- Main PCB damaged.

2.22.5 Procedure

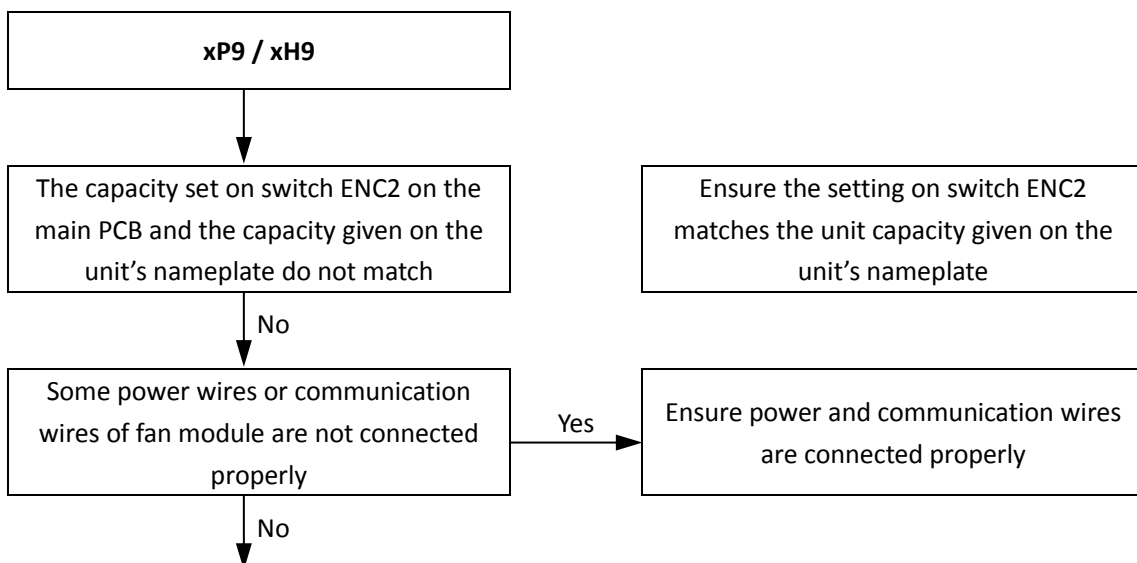

... flowchart continued from previous page

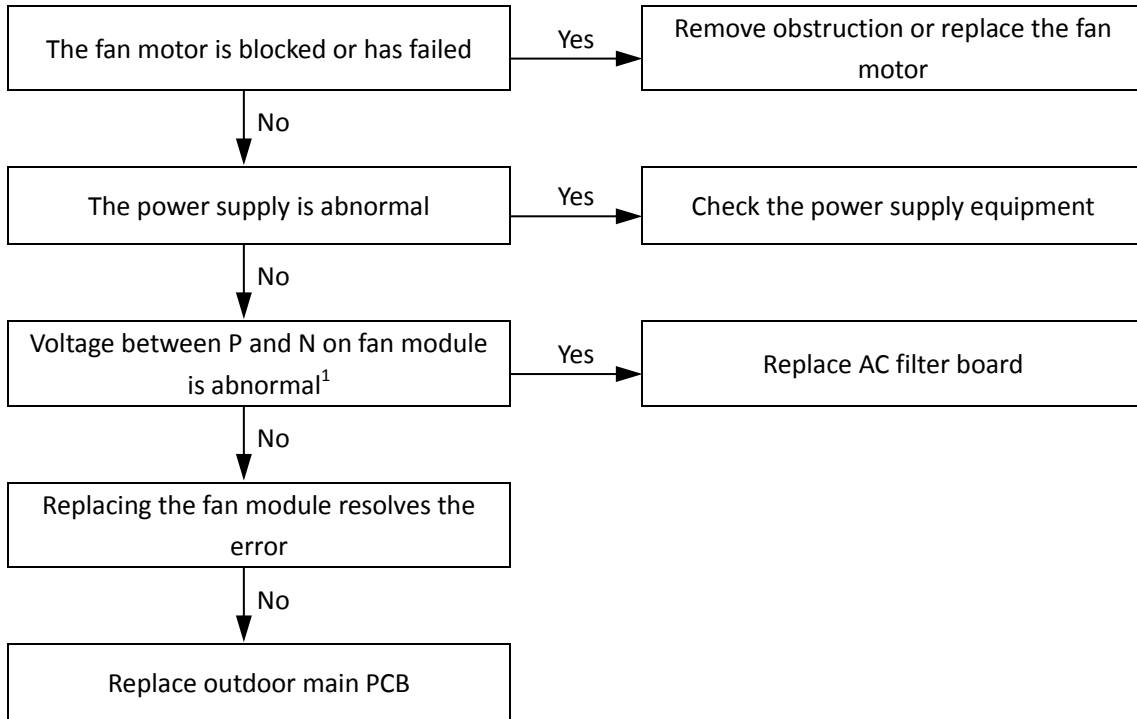

Notes:

1. The normal voltage between P and N on the fan module is 540V DC.

Figure: Fan module P N terminals

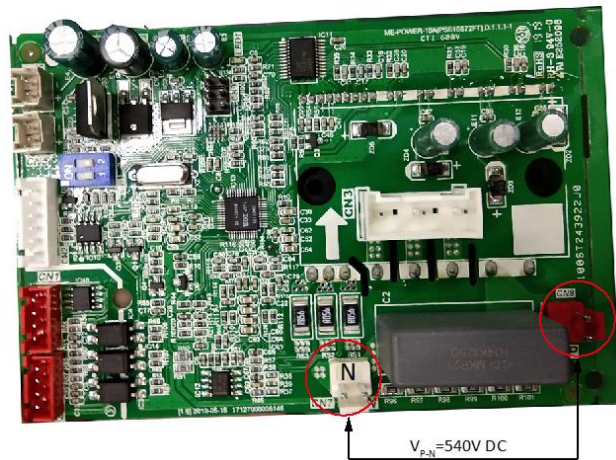

2.23 PL, C7: Inverter module temperature protection

2.23.1 Digital display output

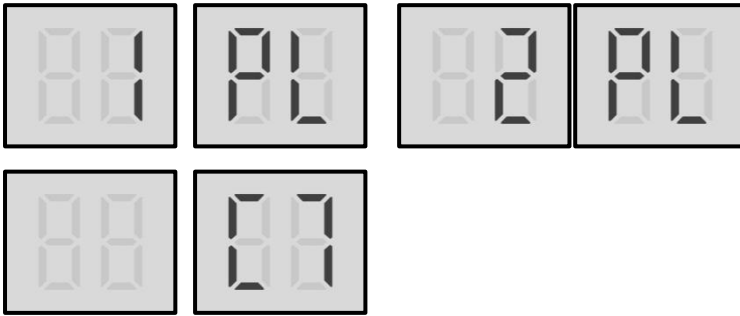

'x' is a placeholder for the compressor system (compressor and related electrical components), with 1 representing compressor system A and 2 representing compressor system B.

2.23.2 Description

- 1PL indicates inverter module A temperature protection.
- 2PL indicates inverter module B temperature protection.
- All units stop running.
- Error code is only displayed on the unit with the error.

2.23.3 Trigger / recover condition

- Trigger condition:
 - For PL protection: Inverter module heat sink temperature (TF1/2) $\geq 80^{\circ}\text{C}$.
 - For C7 protection: PL protection appears three times in 100 minutes.
- Recover condition: Inverter module heat sink temperature (TF1/2) $< 65^{\circ}\text{C}$
- Reset method:
 - For PL protection: Resume automatically.
 - For C7 protection: Manually restart.

2.23.4 Possible causes

- Blocked, dirty or loose heat sink.
- Temperature sensor not connected properly or has malfunctioned.
- Main PCB damaged.

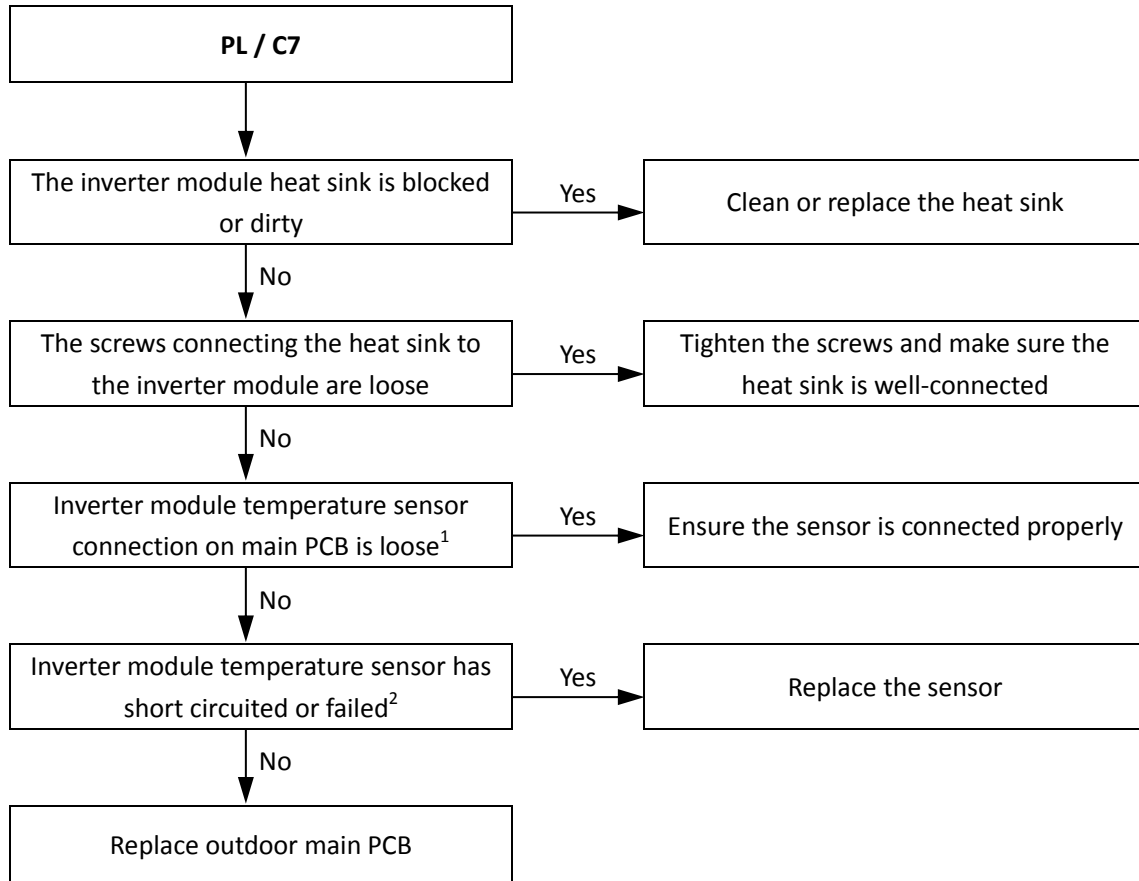
2.23.5 Procedure

Notes:

1. Inverter module temperature sensor connection is port CN3 and CN3_1 on the main PCB (labeled 5 and 6, respectively, in Figure 5-2.1 in Part 5, 2.1 "Ports").
2. Measure sensor resistance. If the resistance is too low, the sensor has short-circuited. If the resistance is not consistent with the sensor's resistance characteristics table, the sensor has failed. Refer to Table 6-3.3 in Part 6, 3.1 "Temperature Sensor Resistance Characteristics".

2.24 PP: Compressor discharge insufficient superheat protection

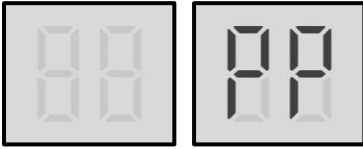
2.24.1 Digital display output



2.24.2 Description

- Compressor discharge insufficient superheat protection.
- All units stop running.
- Error code is only displayed on the unit with the error.

2.24.3 Trigger / recover condition

- Trigger condition: Discharge gas superheat is $\leq 0^{\circ}\text{C}$ for 20 minutes or $\leq 5^{\circ}\text{C}$ for 60 minutes.
- Recover condition: Discharge gas superheat go back to normal value.
- Reset method: Resume automatically.

2.24.4 Possible causes

- Temperature sensor not connected properly or has malfunctioned.
- Poor temperature sensor heat insulation.
- Excess refrigerant.
- Discharge pressure too high.
- Main PCB damaged.

2.24.5 Procedure

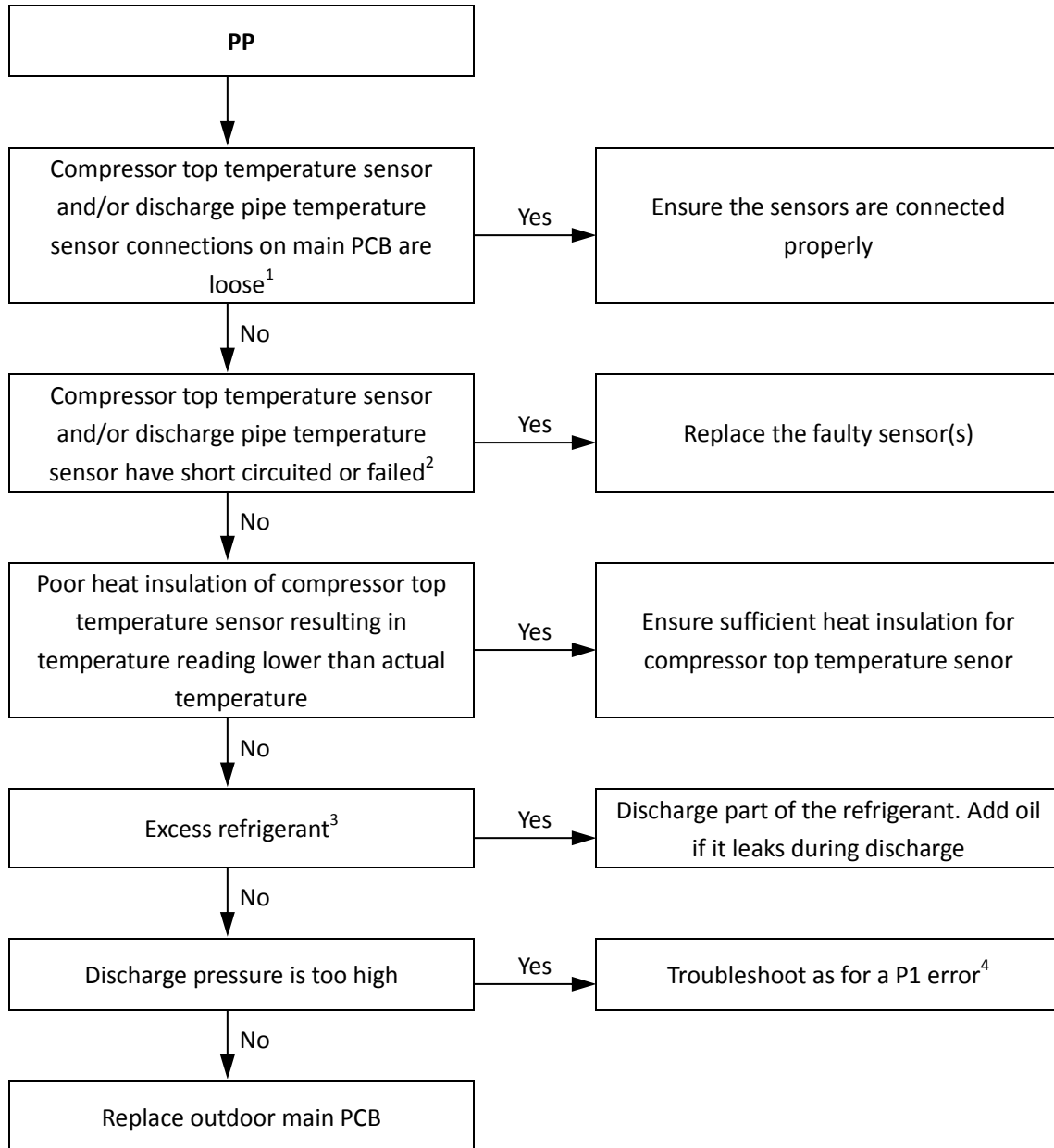

- Notes:
1. Compressor top temperature sensor and discharge pipe temperature sensor connections are ports CN4 and CN5 on the main PCB (labeled 3 and 4, respectively, in Figure 5-2.1 in Part 5, 2.1 "Ports").
 2. Measure sensor resistance. If the resistance is too low, the sensor has short-circuited. If the resistance is not consistent with the sensor's resistance characteristics table, the sensor has failed. Refer to Table 6-3.2 in Part 6, 3.1 "Temperature Sensor Resistance Characteristics".
 3. Excess refrigerant causes discharge temperature to be lower than normal, discharge pressure to be higher than normal and suction pressure to be higher than normal. For normal system parameters refer to Table 6-3.4 in Part 6, 3.2 "Normal Operating Parameters of Refrigerant System".
 4. See "P1 Troubleshooting".

3 Appendix to Part 6

3.1 Temperature Sensor Resistance Characteristics

Table 6-3.1: Outdoor ambient temperature sensor and outdoor heat exchanger temperature sensor resistance characteristics

Temperature (°C)	Resistance (kΩ)	Temperature (°C)	Resistance (kΩ)	Temperature (°C)	Resistance (kΩ)	Temperature (°C)	Resistance (kΩ)
-20	115.3	20	12.64	60	2.358	100	0.6297
-19	108.1	21	12.06	61	2.272	101	0.6115
-18	101.5	22	11.50	62	2.191	102	0.5939
-17	96.34	23	10.97	63	2.112	103	0.5768
-16	89.59	24	10.47	64	2.037	104	0.5604
-15	84.22	25	10.00	65	1.965	105	0.5445
-14	79.31	26	9.551	66	1.896	106	0.5291
-13	74.54	27	9.124	67	1.830	107	0.5143
-12	70.17	28	8.720	68	1.766	108	0.4999
-11	66.09	29	8.336	69	1.705	109	0.4860
-10	62.28	30	7.971	70	1.647	110	0.4726
-9	58.71	31	7.624	71	1.591	111	0.4596
-8	56.37	32	7.295	72	1.537	112	0.4470
-7	52.24	33	6.981	73	1.485	113	0.4348
-6	49.32	34	6.684	74	1.435	114	0.4230
-5	46.57	35	6.400	75	1.387	115	0.4116
-4	44.00	36	6.131	76	1.341	116	0.4006
-3	41.59	37	5.874	77	1.291	117	0.3899
-2	39.82	38	5.630	78	1.254	118	0.3796
-1	37.20	39	5.397	79	1.2133	119	0.3695
0	35.20	40	5.175	80	1.174	120	0.3598
1	33.33	41	4.964	81	1.136	121	0.3504
2	31.56	42	4.763	82	1.100	122	0.3413
3	29.91	43	4.571	83	1.064	123	0.3325
4	28.35	44	4.387	84	1.031	124	0.3239
5	26.88	45	4.213	85	0.9982	125	0.3156
6	25.50	46	4.046	86	0.9668	126	0.3075
7	24.19	47	3.887	87	0.9366	127	0.2997
8	22.57	48	3.735	88	0.9075	128	0.2922
9	21.81	49	3.590	89	0.8795	129	0.2848
10	20.72	50	3.451	90	0.8525	130	0.2777
11	19.69	51	3.318	91	0.8264	131	0.2708
12	18.72	52	3.192	92	0.8013	132	0.2641
13	17.80	53	3.071	93	0.7771	133	0.2576
14	16.93	54	2.959	94	0.7537	134	0.2513
15	16.12	55	2.844	95	0.7312	135	0.2451
16	15.34	56	2.738	96	0.7094	136	0.2392
17	14.62	57	2.637	97	0.6884	137	0.2334
18	13.92	58	2.540	98	0.6682	138	0.2278
19	13.26	59	2.447	99	0.6486	139	0.2223

Table 6-3.2: Compressor top temperature sensor and discharge pipe temperature sensor resistance characteristics

Temperature (°C)	Resistance (kΩ)	Temperature (°C)	Resistance (kΩ)	Temperature (°C)	Resistance (kΩ)	Temperature (°C)	Resistance (kΩ)
-20	542.7	20	68.66	60	13.59	100	3.702
-19	511.9	21	65.62	61	13.11	101	3.595
-18	483.0	22	62.73	62	12.65	102	3.492
-17	455.9	23	59.98	63	12.21	103	3.392
-16	430.5	24	57.37	64	11.79	104	3.296
-15	406.7	25	54.89	65	11.38	105	3.203
-14	384.3	26	52.53	66	10.99	106	3.113
-13	363.3	27	50.28	67	10.61	107	3.025
-12	343.6	28	48.14	68	10.25	108	2.941
-11	325.1	29	46.11	69	9.902	109	2.860
-10	307.7	30	44.17	70	9.569	110	2.781
-9	291.3	31	42.33	71	9.248	111	2.704
-8	275.9	32	40.57	72	8.940	112	2.630
-7	261.4	33	38.89	73	8.643	113	2.559
-6	247.8	34	37.30	74	8.358	114	2.489
-5	234.9	35	35.78	75	8.084	115	2.422
-4	222.8	36	34.32	76	7.820	116	2.357
-3	211.4	37	32.94	77	7.566	117	2.294
-2	200.7	38	31.62	78	7.321	118	2.233
-1	190.5	39	30.36	79	7.086	119	2.174
0	180.9	40	29.15	80	6.859	120	2.117
1	171.9	41	28.00	81	6.641	121	2.061
2	163.3	42	26.90	82	6.430	122	2.007
3	155.2	43	25.86	83	6.228	123	1.955
4	147.6	44	24.85	84	6.033	124	1.905
5	140.4	45	23.89	85	5.844	125	1.856
6	133.5	46	22.89	86	5.663	126	1.808
7	127.1	47	22.10	87	5.488	127	1.762
8	121.0	48	21.26	88	5.320	128	1.717
9	115.2	49	20.46	89	5.157	129	1.674
10	109.8	50	19.69	90	5.000	130	1.632
11	104.6	51	18.96	91	4.849		
12	99.69	52	18.26	92	4.703		
13	95.05	53	17.58	93	4.562		
14	90.66	54	16.94	94	4.426		
15	86.49	55	16.32	95	4.294		
16	82.54	56	15.73	96	4.167		
17	78.79	57	15.16	97	4.045		
18	75.24	58	14.62	98	3.927		
19	71.86	59	14.09	99	3.812		

Table 6-3.3: Inverter module temperature sensor resistance characteristics

Temperature (°C)	Resistance (kΩ)	Temperature (°C)	Resistance (kΩ)	Temperature (°C)	Resistance (kΩ)	Temperature (°C)	Resistance (kΩ)
-30	971.4	10	109.0	50	19.70	90	5.000
-29	912.8	11	103.9	51	18.97	91	4.855
-28	858.2	12	99.02	52	18.26	92	4.705
-27	807.3	13	94.44	53	17.59	93	4.566
-26	759.7	14	90.11	54	16.94	94	4.431
-25	715.3	15	86.00	55	16.32	95	4.301
-24	673.6	16	82.09	56	15.73	96	4.176
-23	634.7	17	78.38	57	15.16	97	4.055
-22	598.2	18	74.87	58	14.62	98	3.938
-21	564.1	19	71.53	59	14.10	99	3.825
-20	532.2	20	68.36	60	13.60	100	3.716
-19	502.2	21	65.34	61	13.12	101	3.613
-18	474.1	22	62.47	62	12.65	102	3.514
-17	447.7	23	59.75	63	12.22	103	3.418
-16	423.0	24	57.17	64	11.79	104	3.326
-15	399.8	25	54.71	65	11.39	105	3.235
-14	378.0	26	52.36	66	10.99	106	3.148
-13	357.5	27	50.13	67	10.62	107	3.063
-12	338.2	28	48.01	68	10.25	108	2.982
-11	320.1	29	45.99	69	9.909	109	2.902
-10	303.1	30	44.07	70	9.576	110	2.826
-9	287.1	31	42.23	71	9.253	111	2.747
-8	272.0	32	40.48	72	8.947	112	2.672
-7	257.8	33	38.81	73	8.646	113	2.599
-6	244.4	34	37.23	74	8.362	114	2.528
-5	231.9	35	35.71	75	8.089	115	2.460
-4	220.0	36	34.27	76	7.821	116	2.390
-3	208.7	37	32.89	77	7.569	117	2.322
-2	198.2	38	31.58	78	7.323	118	2.256
-1	188.2	39	30.33	79	7.088	119	2.193
0	178.8	40	29.13	80	6.858	120	2.132
1	169.9	41	27.98	81	6.640	121	2.073
2	161.5	42	26.89	82	6.432	122	2.017
3	153.6	43	25.85	83	6.230	123	1.962
4	146.1	44	24.85	84	6.033	124	1.910
5	139.1	45	23.90	85	5.847	125	1.859
6	132.3	46	22.98	86	5.667		
7	126.0	47	22.10	87	5.492		
8	120.0	48	21.26	88	5.322		
9	114.3	49	20.47	89	5.159		

3.2 Normal Operating Parameters of Refrigerant System

Under the following conditions, the operating parameters given in Tables 6-3.4 should be observed:

- The master outdoor unit can detect all the indoor units.
- The number of indoor units displayed on DSP2 is steady and is equal to the actual number of indoor units installed.
- All stop valves are open and all indoor unit EXVs are connected to their unit's PCB.
- If the combination ratio is 100% or less, all the indoor units are currently running and if the combination ratio is more than 100%, indoor units with total capacity equal to the total capacity of the outdoor units are currently running.
- The system is being run in cooling mode with the following settings: temperature 17°C; fan speed high.
- The system has been running normally for more than 30 minutes.

Table 6-3.4: Outdoor unit cooling mode operating parameters

Outdoor ambient temperature	°C	< 10	10 to 26	26 to 31	31 to 41	> 41
Discharge temperature	°C	60-76	62-78	65-82	67-92	69-92
Discharge superheat	°C	17-30	17-33	17-34	17-36	10-32
Discharge pressure	MPa	2.3-2.8	2.3-2.8	2.4-3.6	2.6-3.8	3.1-4.2
Suction pressure	MPa	0.6-0.7	0.7-0.9	0.8-1.0	1.0-1.2	1.2-1.4